



Gefäßklemmen aus Edelstahl
Stainless Steel Vascular Clamps
Pinzas vasculares acero inoxidable
Pincés vasculaires acier inoxydable
Pinze vascolari acciaio inossidabile



Gefäßklemmen aus Edelstahl

Stainless Steel Vascular Clamps

Pinzas vasculares acero inoxidable

Pinces vasculaires acier inoxydable

Pinze vascolari acciaio inossidabile

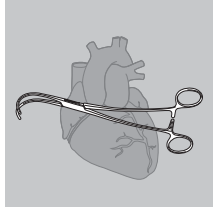

De-Bakey-Zahnung
De Bakey serration
De Bakey dentado
De Bakey denture
De Bakey dentatura



De-Bakey-Baby-Zahnung
De Bakey baby serration
De Bakey baby dentado
De Bakey baby denture
De Bakey baby dentatura



Cooley-Zahnung
Cooley serration
Cooley dentado
Cooley denture
Cooley dentatura

Aortaklemmen

Aortic Clamps

Pinzas aórticas

Pinces-clamps pour aorte

Pinze per aorta

Atrauma



1/2

Ochsner
24-317-23-07
22 cm / 8 5/8"



1/2

Diethrich
24-319-21-07
21 cm / 8 2/8"

Peripheral-Gefäßklemmen

Peripheral Vascular Clamps
 Pinzas para vasos periféricos
 Pincers-clamps vasculaires périphériques
 Pinze vascolari periferali

Gefäßklemmen aus Edelstahl

Stainless Steel Vascular Clamps
 Pinzas vasculares acero inoxidable
 Pincers vasculaires acier inoxydable
 Pinze vascolari acciaio inossidabile

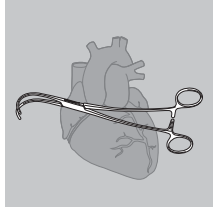

Atrauma

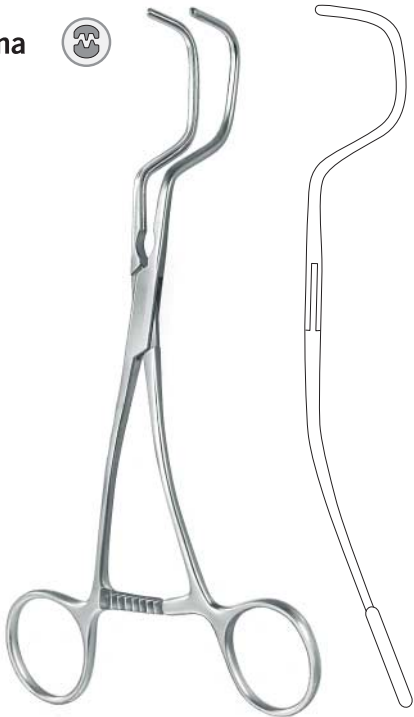

1/1

1/2

Dale
 24-340-18-07
 18 cm / 7 1/8"



1/1

24-341-17-07
 17,5 cm / 6 7/8"

24-341-18-07
 18 cm / 7 1/8"

24-341-19-07
 18,5 cm / 7 2/8"

1/2

Dale
 24-341-17-07 -
 24-341-19-07

Profundaklemmen

Profunda Clamps

Pinzas para la profunda

Pinces fémorale

Pinze profunda

Atrauma



1/2



Gregory
24-342-14-07 -
24-342-18-07

1/1

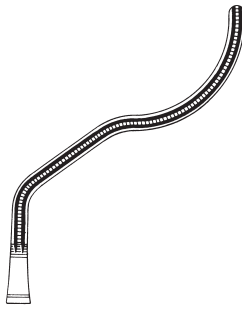

24-342-14-07
13,5 cm / 5 3/8"

1/1

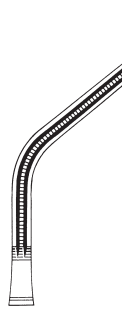

24-342-16-07
16 cm / 6 2/8"

1/1

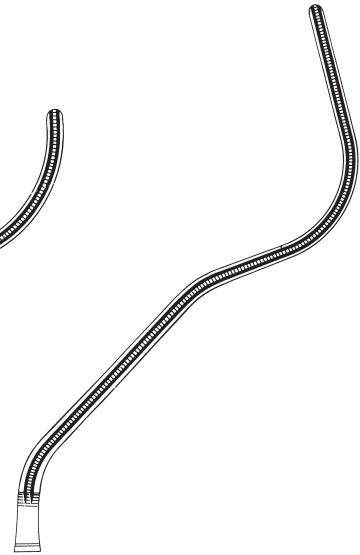

24-342-18-07
18 cm / 7 1/8"

Carotis-Shuntklemmen

Carotid Shunt Clamps
Pinzas para shunt carótido
Pincés pour carotide
Pinze carotis

Gefäßklemmen aus Edelstahl

Stainless Steel Vascular Clamps
Pinzas vasculares acero inoxidable
Pincés vasculaires acier inoxydable
Pinze vascolari acciaio inossidabile

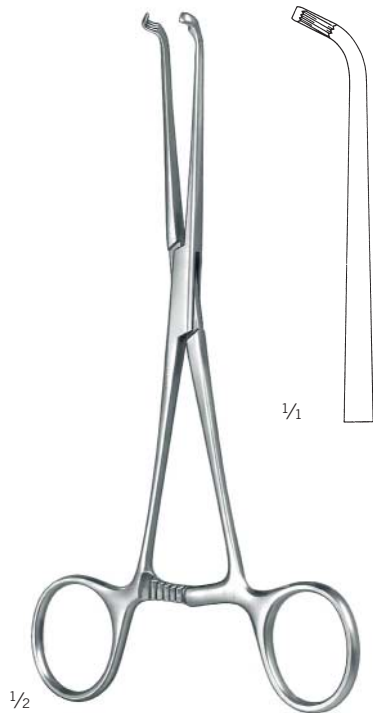
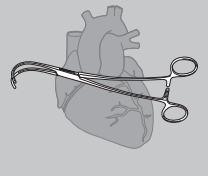

Javid
24-343-18-07
17,5 cm / 6 7/8"



Javid
24-343-19-07
18,5 cm / 7 3/8"

Peripheral-Gefäßklemmen

Peripheral Vascular Clamps

Pinzas para vasos periféricos

Pinces-clamps vasculaires périphériques

Pinze vascolari periferali

Atrauma



1/2

Martin
24-344-16-07 -
24-344-18-07

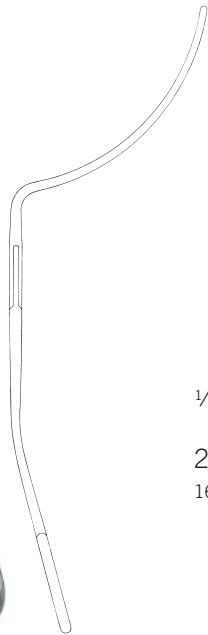

1/1

24-344-16-07
16 cm / 6 2/8"

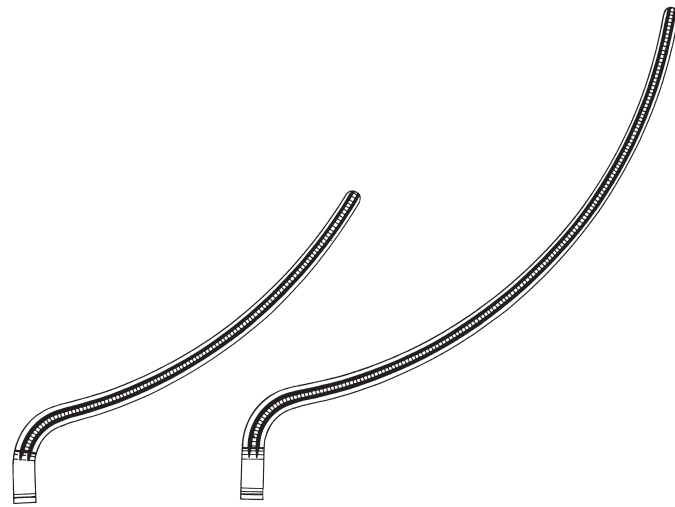

24-344-18-07
18 cm / 7 1/8"



1/2

Martin
24-344-17-07 -
24-344-20-07

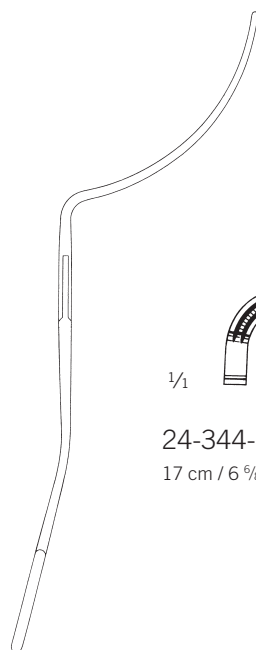

1/1

24-344-17-07
17 cm / 6 6/8"

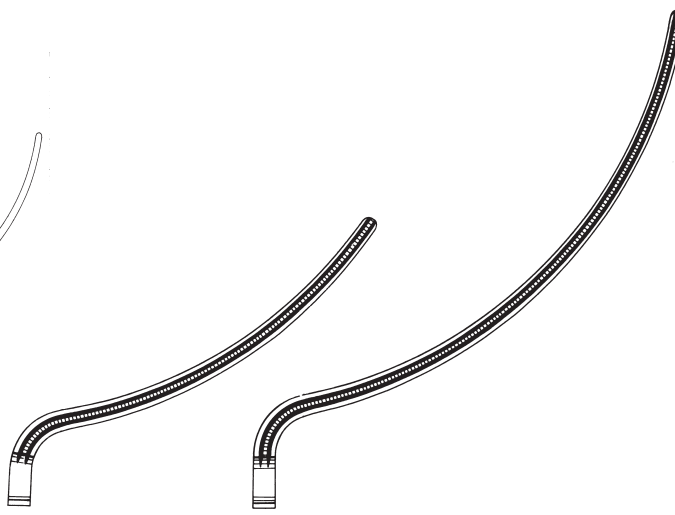

24-344-20-07
19,5 cm / 7 5/8"

Aortaklemmen

Aortic Clamps

Pinzas aórticas

Pinces-clamps pour aorte

Pinze per aorta

Gefäßklemmen aus Edelstahl

Stainless Steel Vascular Clamps

Pinzas vasculares acero inoxidable

Pinces vasculaires acier inoxydable

Pinze vascolari acciaio inossidabile

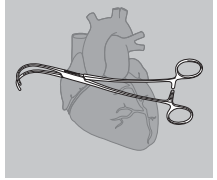

Atrauma



Wylie
24-344-24-07
24 cm / 9 4/8"



Wylie
24-344-27-07
27 cm / 10 5/8"

Aortaklemmen

Aortic Clamps

Pinzas aórticas

Pinces-clamps pour aorte

Pinze per aorta

Atrauma

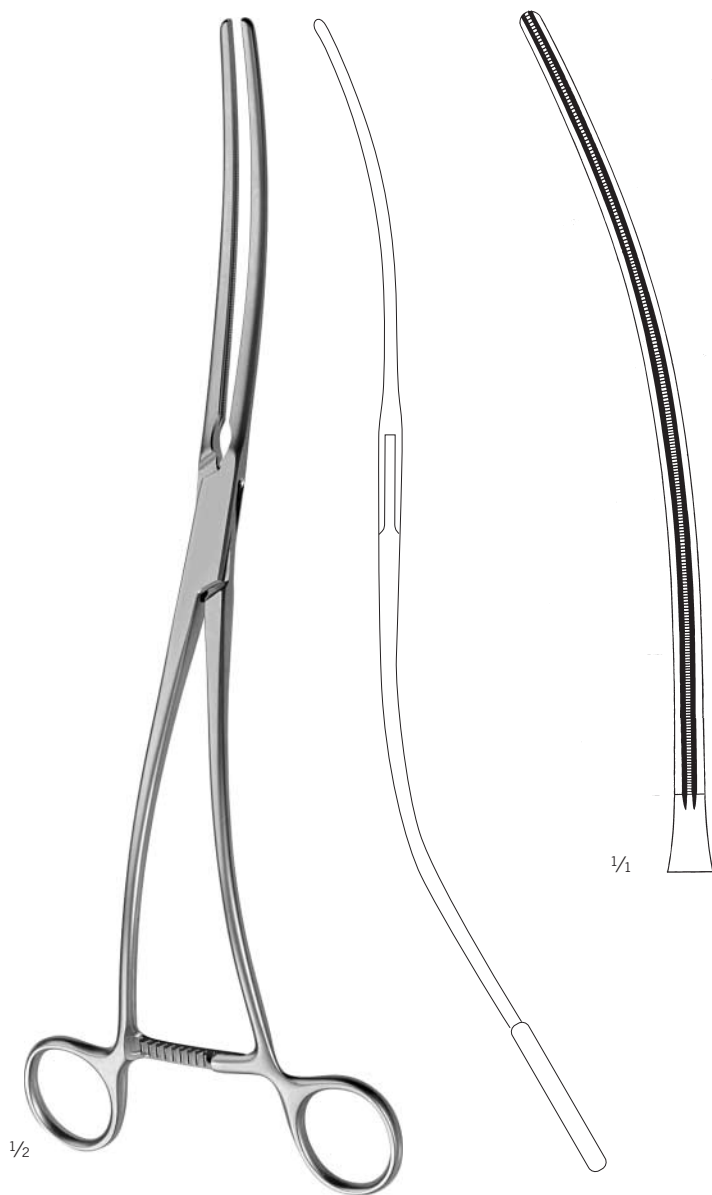

De Bakey
24-344-30-07
30 cm / 11 ⁶/₈"

Peripheral-Gefäßklemmen

Peripheral Vascular Clamps

Pinzas para vasos periféricos

Pinces-clamps vasculaires périphériques

Pinze vascolari periferali

Gefäßklemmen aus Edelstahl

Stainless Steel Vascular Clamps

Pinzas vasculares acero inoxidable

Pinces vasculaires acier inoxydable

Pinze vascolari acciaio inossidabile

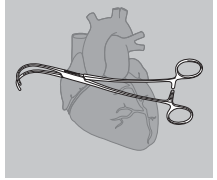

Atrauma

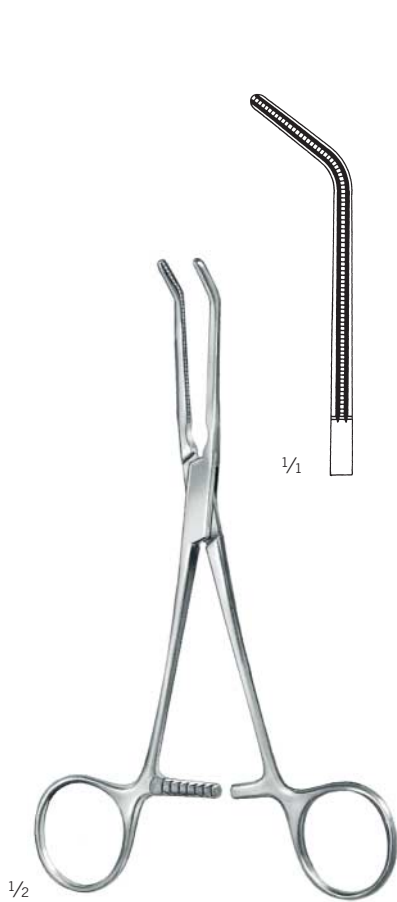

Husfeldt
24-345-18-07
16,5 cm / 6 4/8"

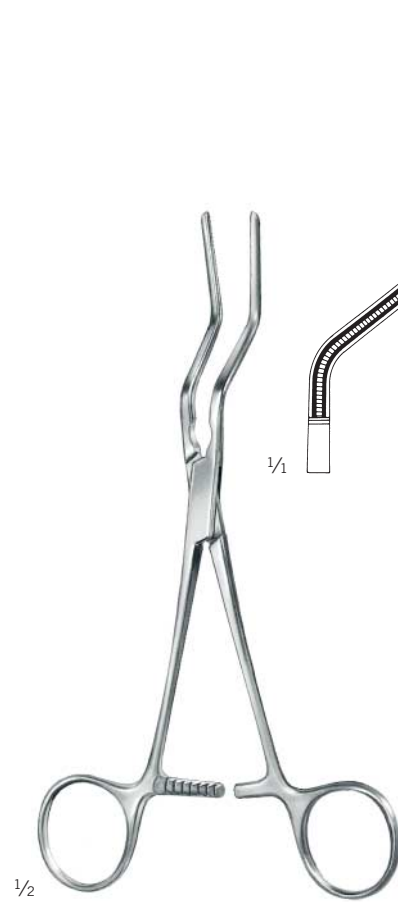

Husfeldt
24-347-18-07
18 cm / 7 1/8"



Husfeldt
24-349-17-07
17 cm / 6 5/8"

Peripheral-Gefäßklemmen

Peripheral Vascular Clamps

Pinzas para vasos periféricos

Pinces-clamps vasculaires périphériques

Pinze vascolari periferali

Atrauma



$\frac{1}{2}$

Henly
24-349-20-07
20 cm / 7 ⁷/₈"

Abdominale Aortaklemmen

Abdominal Aortic Clamps

Pinzas aórticas abdominales

Pinces-clamps pour aorte abdominaux

Pinze per aorta addominali

Gefäßklemmen aus Edelstahl

Stainless Steel Vascular Clamps

Pinzas vasculares acero inoxidable

Pinces vasculaires acier inoxydable

Pinze vascolari acciaio inossidabile

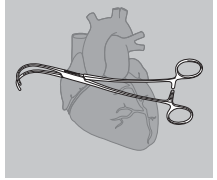

Atrauma

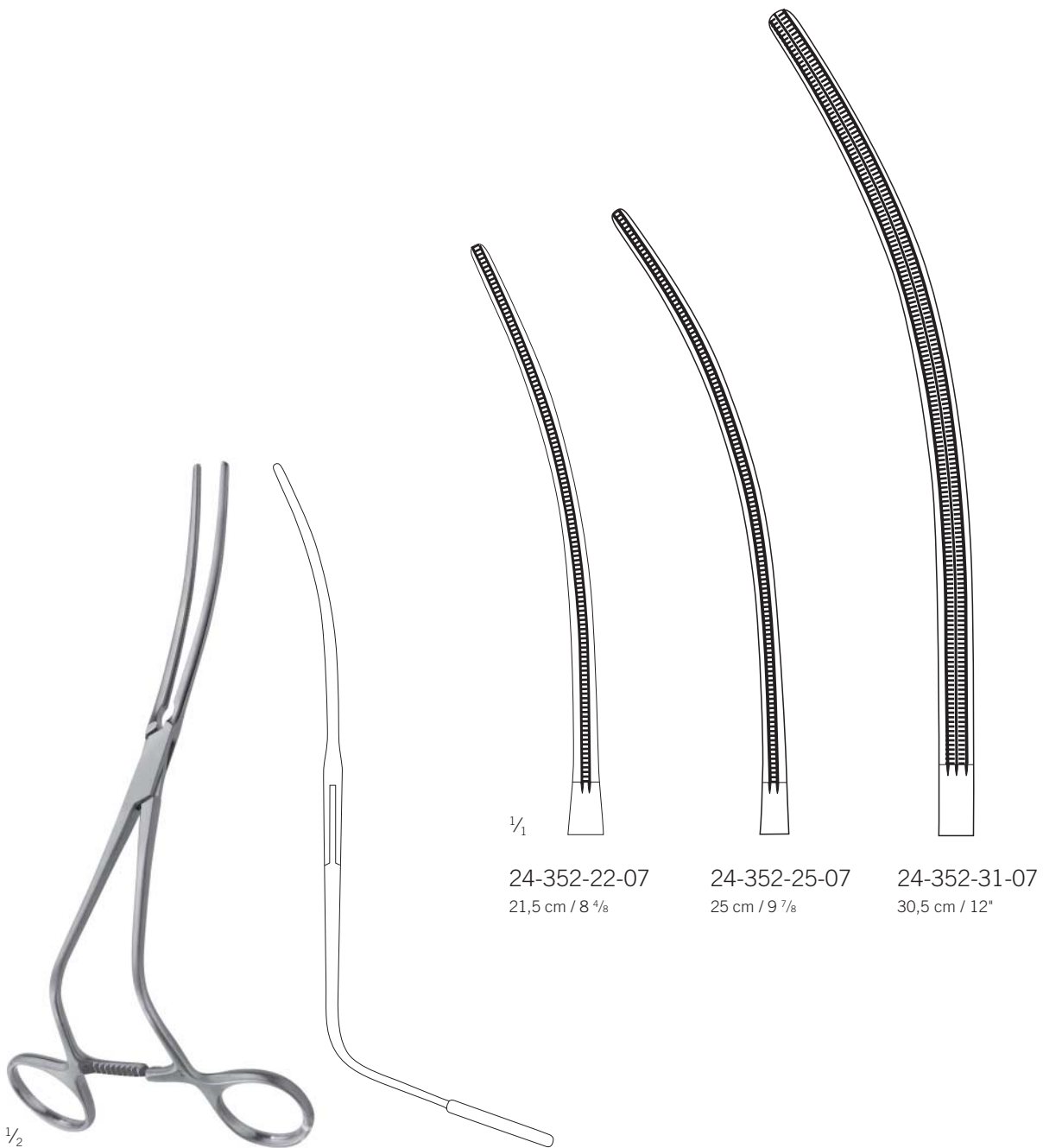

Zanger
24-352-22-07 -
24-352-31-07

Abdominale Aortaklemmen

Abdominal Aortic Clamps

Pinzas aórticas abdominales

Pinces-clamps pour aorte abdominaux

Pinze per aorta addominali

Atrauma

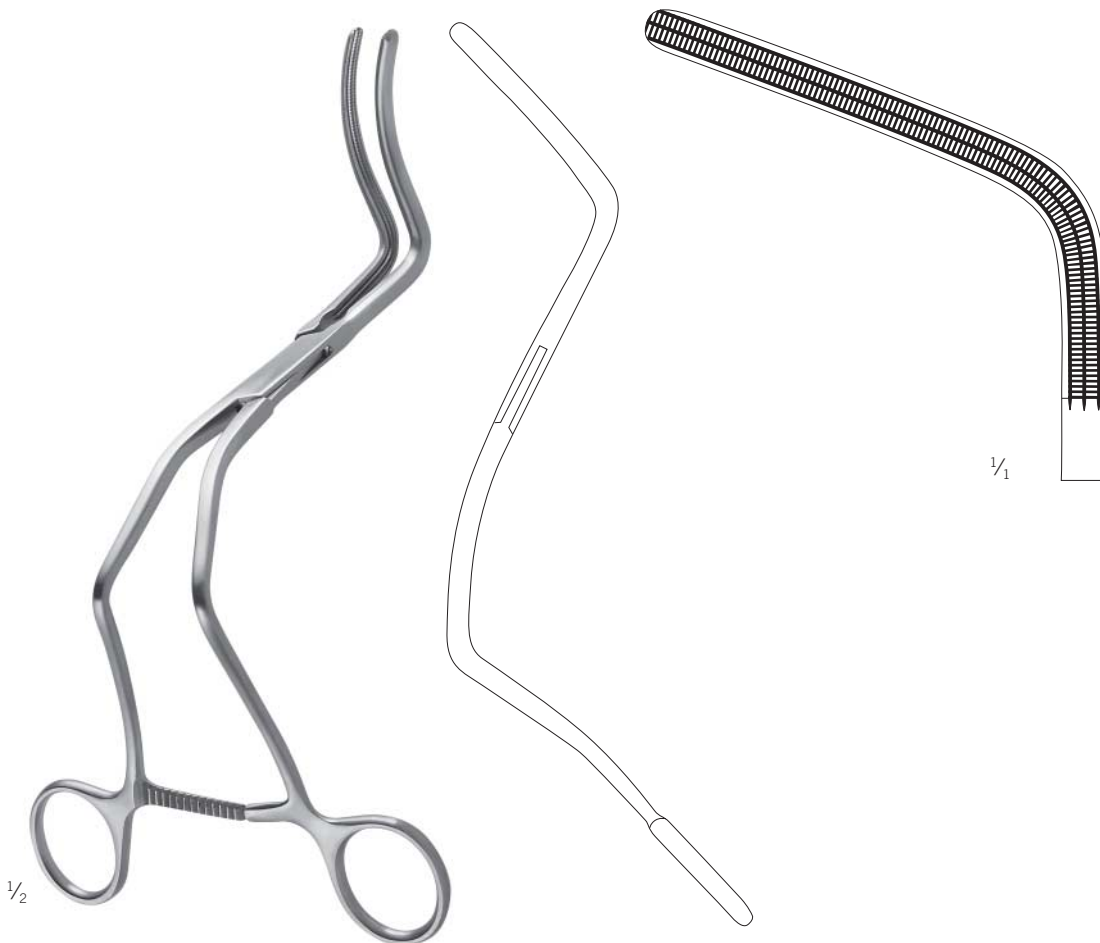

Grant
24-353-25-07
24,5 cm / 9 5/8

Coarctationsklemmen

Coarctation Clamps

Pinzas para coarctación

Pinces-clamps pour coarctation

Pinze per coartazione

Gefäßklemmen aus Edelstahl

Stainless Steel Vascular Clamps

Pinzas vasculares acero inoxidable

Pinces vasculaires acier inoxydable

Pinze vascolari acciaio inossidabile

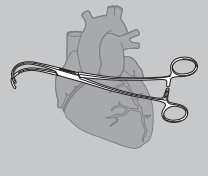

Atrauma



1/1

24-400-21-07
21 cm / 8 2/8"



24-400-22-07
22,5 cm / 8 7/8"



1/2

Potts
24-401-21-07 -
24-401-22-07

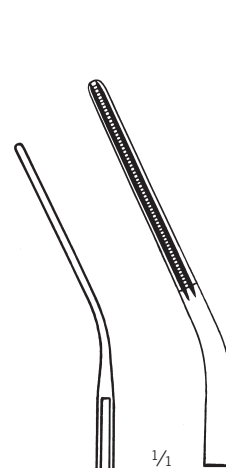

1/1

24-401-21-07
20,5 cm / 8 1/8"

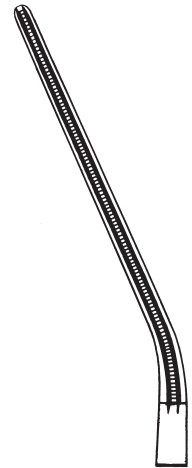

24-401-22-07
22 cm / 8 5/8"

Coarctationsklemmen

Coarctation Clamps

Pinzas para coarctación

Pinces-clamps pour coarctation

Pinze per coartazione

Atrauma



1/2

Potts
24-403-21-07 -
24-403-22-07

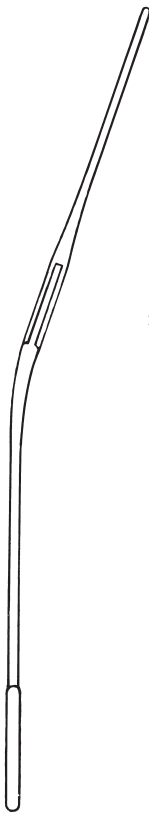

1/1

24-403-21-07
20,5 cm / 8"

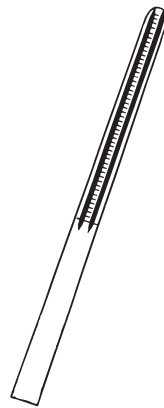

24-403-22-07
22 cm / 8 5/8"

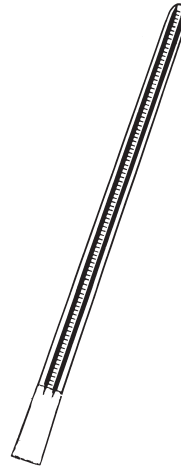

Anastomosenklemmen, Ligaturklemmen

Anastomosis Clamps, Ligature Forceps
Pinzas para anastomosis, Pinzas para ligaduras
Pincers-clamps à anastomose, Pincers à ligatures
Pinze per anastomosi, Pinze per legature

Gefäßklemmen aus Edelstahl

Stainless Steel Vascular Clamps
Pinzas vasculares acero inoxidable
Pincers vasculaires acier inoxydable
Pinze vascolari acciaio inossidabile

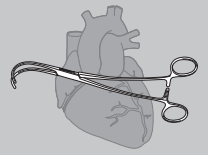

Atrauma



1/1

24-405-22-07
21,5 cm / 8 4/8"

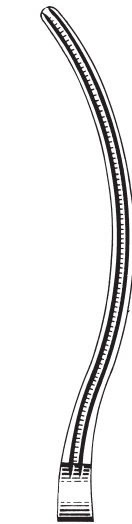

24-407-22-07
22 cm / 8 5/8"



1/1

24-408-19-07
19 cm / 7 4/8"

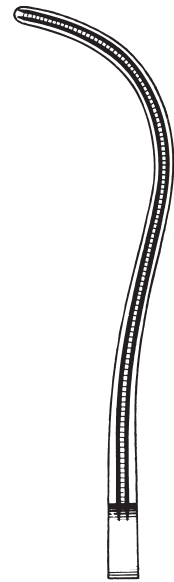

24-408-23-07
24 cm / 9 4/8"

1/2

Potts
24-405-22-07 -
24-407-22-07

1/2

De Bakey
24-408-19-07 -
24-408-23-07

Peripheral-Gefäßklemmen

Peripheral Vascular Clamps

Pinzas para vasos periféricos

Pinces-clamps vasculaires périphériques

Pinze vascolari periferali

Atrauma



De Bakey
24-409-16-07
16 cm / 6 ²/₈"



De Bakey
24-411-19-07
19 cm / 7 ⁴/₈"

Gefäßklemmen aus Edelstahl

Stainless Steel Vascular Clamps
Pinzas vasculares acero inoxidable
Pinces vasculaires acier inoxydable
Pinze vascolari acciaio inossidabile

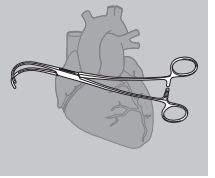

Atrauma



De Bakey
24-411-20-07
20 cm / 7 7/8"

Peripheral-Gefäßklemmen

Peripheral Vascular Clamps

Pinzas para vasos periféricos

Pinces-clamps vasculaires périphériques

Pinze vascolari periferali

Atrauma

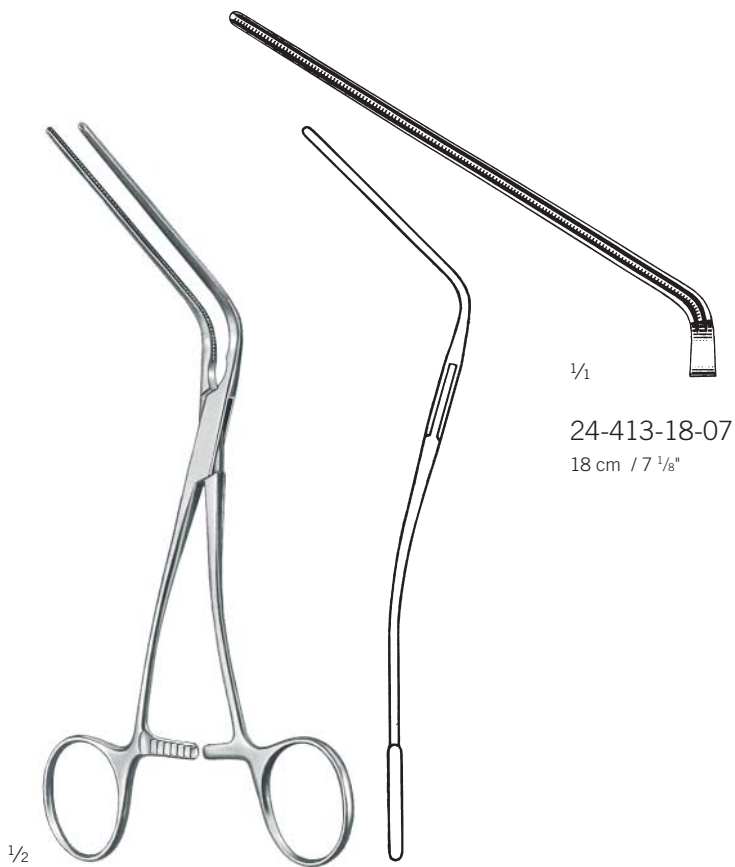

$\frac{1}{2}$

24-413-18-07

18 cm / 7 $\frac{1}{8}$ "

$\frac{1}{2}$

Leland-Jones
24-413-18-07 -
24-413-20-07

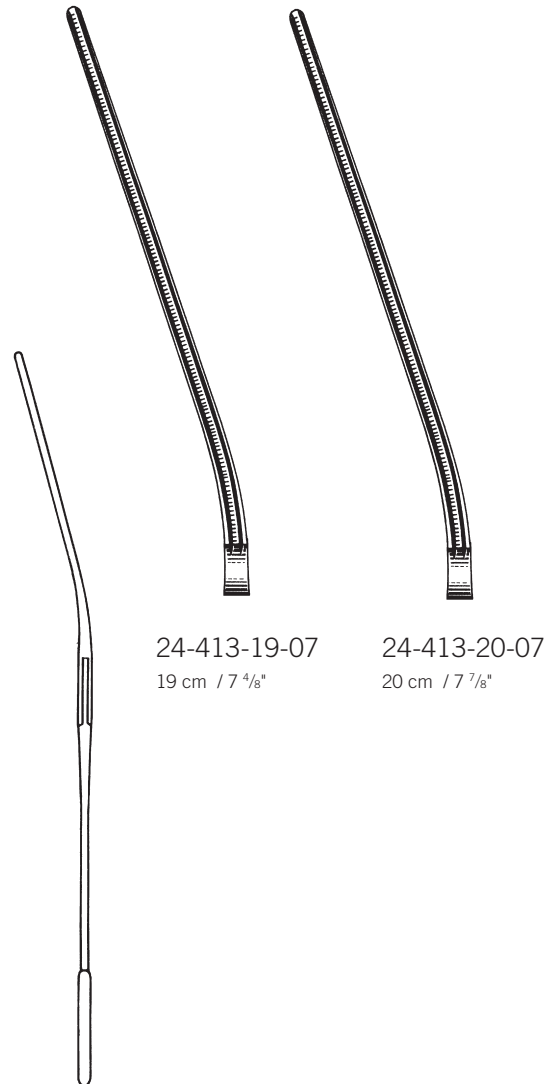

24-413-19-07

19 cm / 7 $\frac{4}{8}$ "

24-413-20-07

20 cm / 7 $\frac{7}{8}$ "

Mehrzweck-Gefäßklemmen

Multi purpose Vascular Clamps
Pinzas vasculares de usos múltiples
Pincas vasculaires universelles
Pinze vascolari universali

Gefäßklemmen aus Edelstahl

Stainless Steel Vascular Clamps
Pinzas vasculares acero inoxidable
Pincas vasculaires acier inoxydable
Pinze vascolari acciaio inossidabile

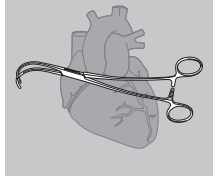

Atrauma



1/2

Bainbridge
24-414-15-07 -
24-414-18-07

1/1



24-414-15-07
15 cm / 5 7/8"



24-414-18-07
18,5 cm / 7 2/8"

Mehrzweck-Gefäßklemmen

Multi purpose Vascular Clamps
Pinzas vasculares de usos múltiples
Pincas vasculaires universelles
Pinze vascolari universali

Atrauma



1/2

Bainbridge
24-415-15-07 -
24-415-18-07

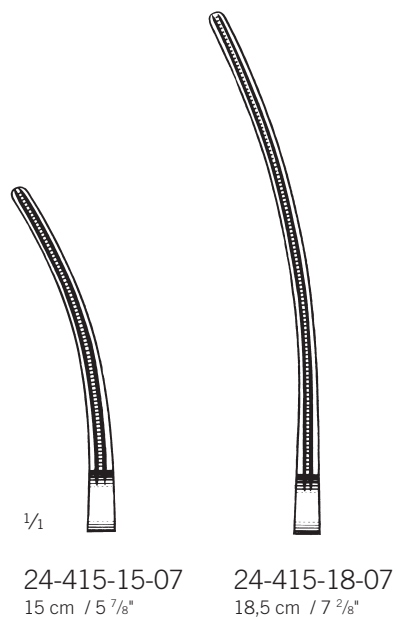

1/1

24-415-15-07
15 cm / 5 7/8"

24-415-18-07
18,5 cm / 7 2/8"

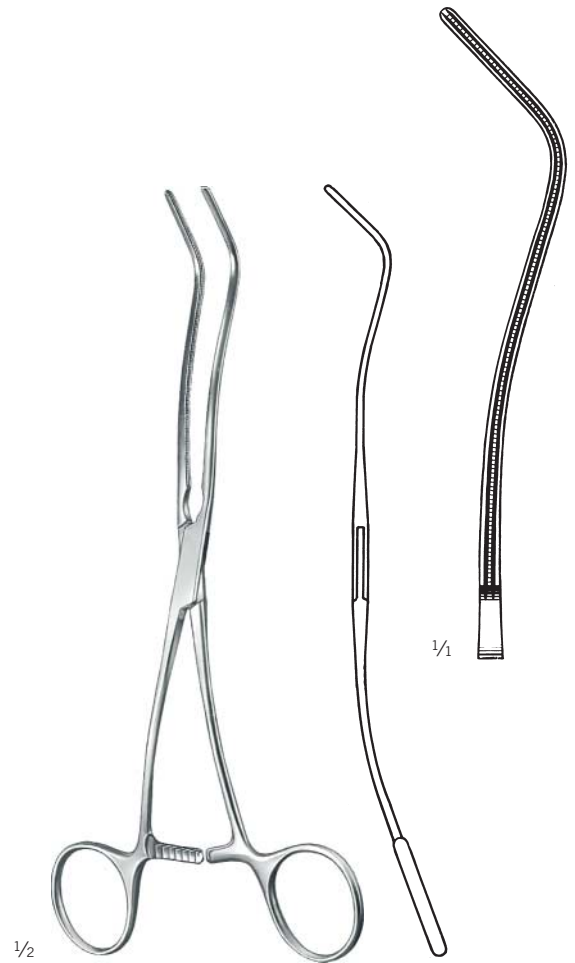

1/2

De Bakey
24-416-20-07
20 cm / 7 7/8"

1/1

Aorta-Aneurysmaklemmen

Aortic Aneurysm Clamps

Pinzas para aneurisma de aórtica

Pinces-clamps pour anévrisme de l'aorte

Pinze per aneurisma della aorta

Gefäßklemmen aus Edelstahl

Stainless Steel Vascular Clamps

Pinzas vasculares acero inoxidable

Pinces vasculaires acier inoxydable

Pinze vascolari acciaio inossidabile

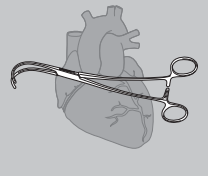

Atrauma



1/2

De Bakey
24-417-26-07 -
24-417-33-07

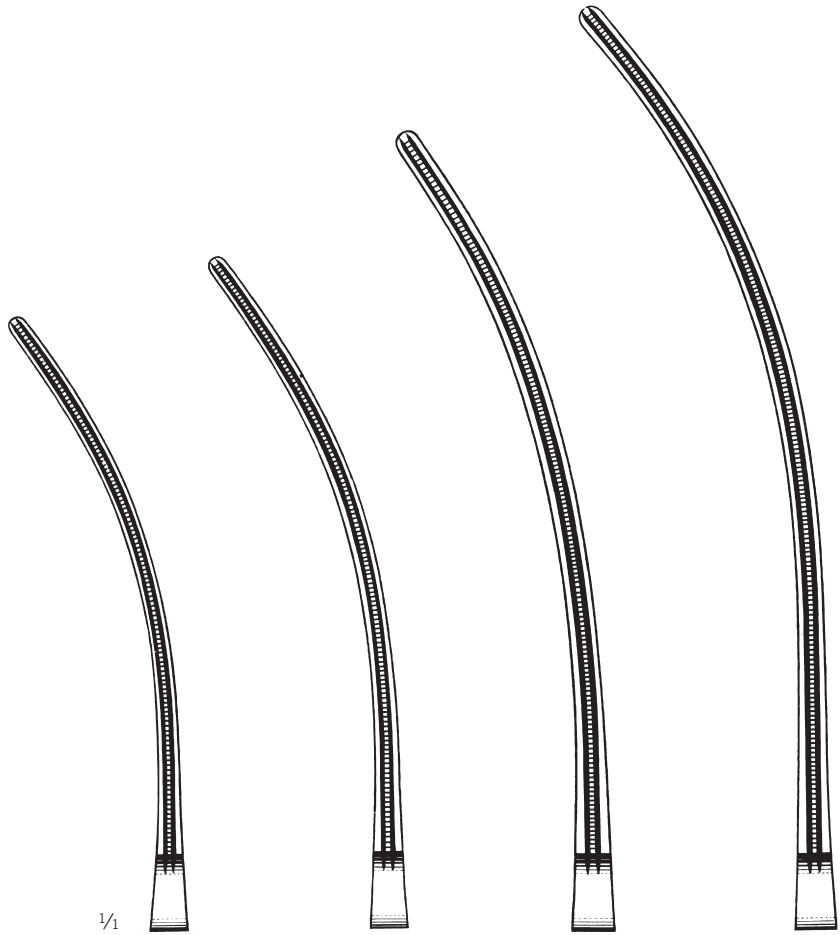

1/1

24-417-26-07
26 cm / 10 2/8"

24-417-27-07
27 cm / 10 5/8"

24-417-31-07
31 cm / 12 2/8"

24-417-33-07
33 cm / 13"

Aorta-Aneurysmaklemmen

Aortic Aneurysm Clamps

Pinzas para aneurisma de aórtica

Pinces-clamps pour anévrisme de l'aorte

Pinze per aneurisma della aorta

Atrauma



De Bakey
24-418-28-07
28 cm / 11"

De Bakey
24-419-30-07
30 cm / 11 6/8"

Gefäßklemmen aus Edelstahl

Stainless Steel Vascular Clamps
Pinzas vasculares acero inoxidable
Pinces vasculaires acier inoxydable
Pinze vascolari acciaio inossidabile

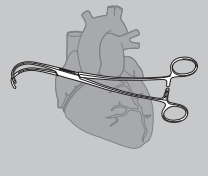

Atrauma

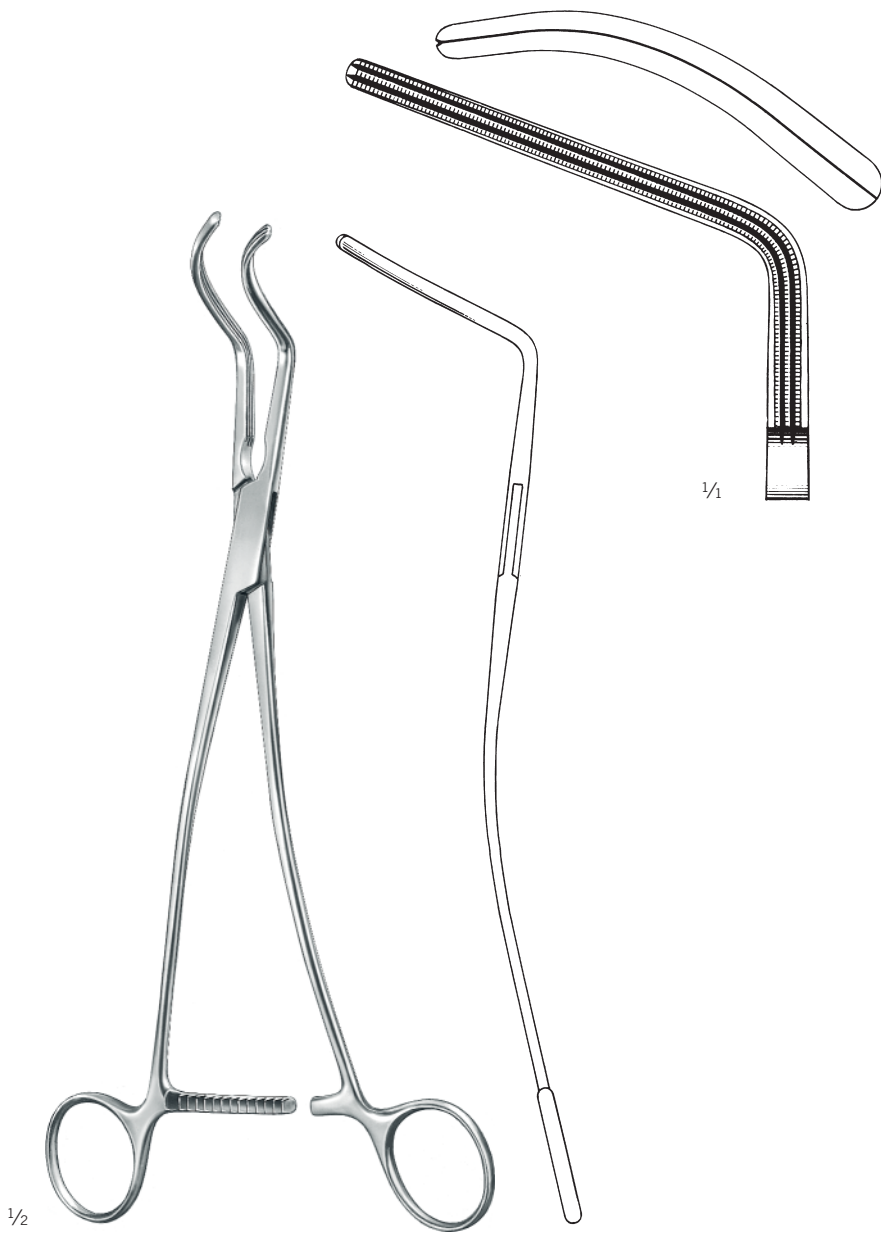

De Bakey
24-420-27-07
27 cm / 10 5/8"

Ligaturklemmen, Aortaklemmen

Ligature Forceps, Aortic Clamps

Pinzas para ligaduras, Pinzas aórticas

Pinces à ligatures, Pincés-clamps pour aorte

Pinze per legature, Pinze per aorta

Atrauma



De Bakey
24-421-24-07
24,5 cm / 9 5/8"



De Bakey
24-422-24-07
24,5 cm / 9 5/8"

Gefäßklemmen aus Edelstahl

Stainless Steel Vascular Clamps
Pinzas vasculares acero inoxidable
Pinces vasculaires acier inoxydable
Pinze vascolari acciaio inossidabile

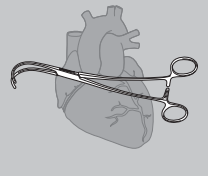

Atrauma

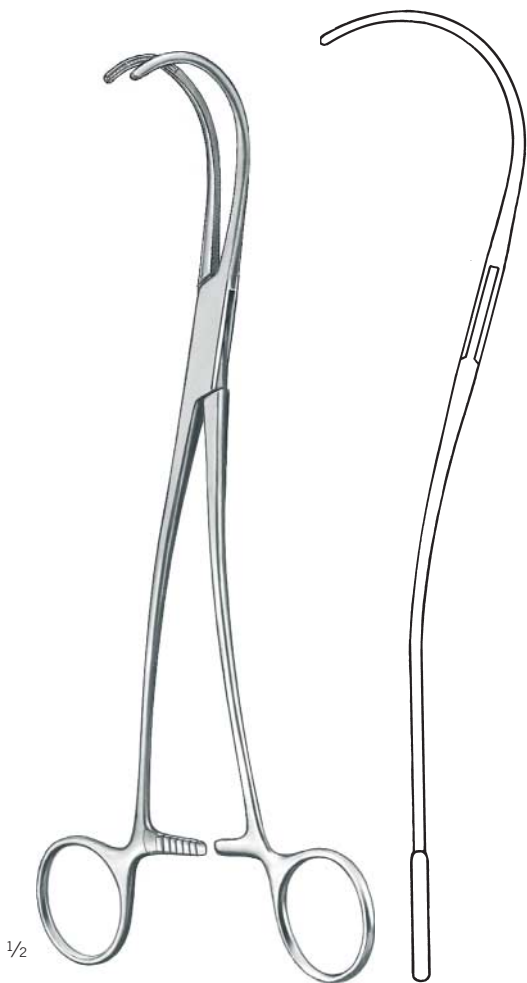

1/2

De Bakey
24-423-25-07 -
24-423-26-07
27 cm / 10 5/8"

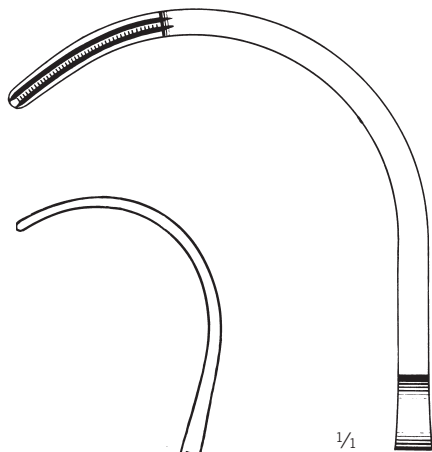

1/1

24-423-25-07

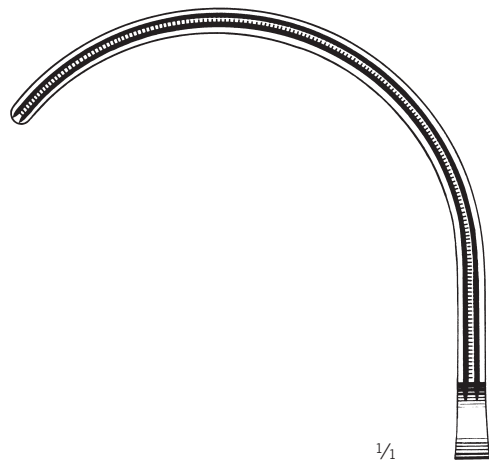

1/1

24-423-26-07

Aortaklemmen

Aortic Clamps

Pinzas aórticas

Pinces-clamps pour aorte

Pinze per aorta

Atrauma

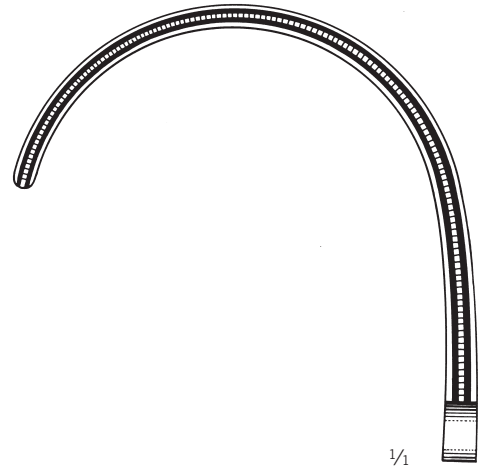
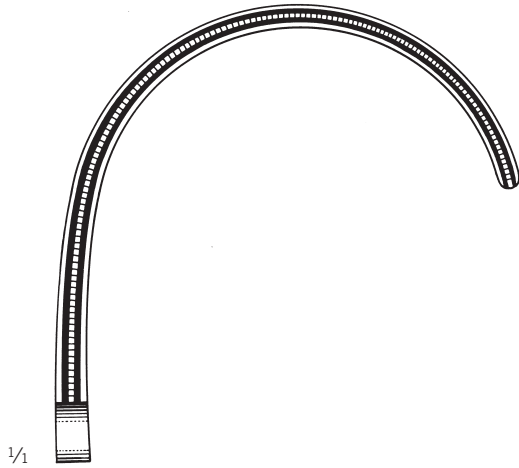

Weber
24-424-01-07
24 cm / 9 4/8"

Weber
24-424-02-07
24 cm / 9 4/8"

Gefäßklemmen aus Edelstahl

Stainless Steel Vascular Clamps
 Pinzas vasculares acero inoxidable
 Pinces vasculaires acier inoxydable
 Pinze vascolari acciaio inossidabile

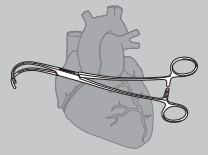

Atrauma



1/1

24-424-03-07
 22,5 cm / 8 7/8"

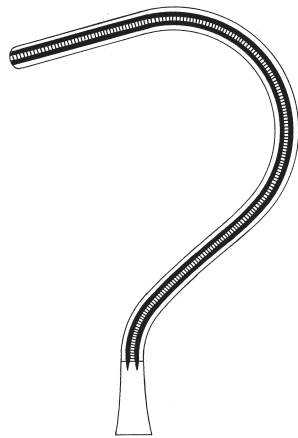

24-424-04-07
 23 cm / 9"

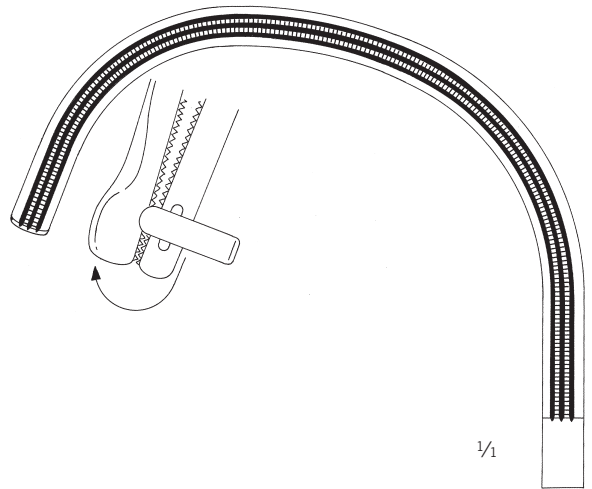

1/1



1/2

Wylie
 24-424-03-07 -
 24-424-04-07



1/2

Calne
 24-425-00-07
 27 cm / 10 5/8"

Tangentialklemmen

Tangential Occlusion Clamps

Pinzas para oclusión tangencial

Pinces-clamps pour occlusion tangentielle

Pinze per occlusione tangenziale

Atrauma

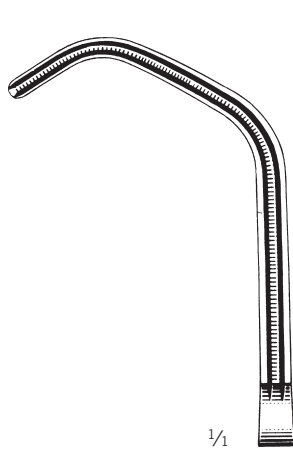

1/4

24-425-20-07
22 cm / 8 5/8"

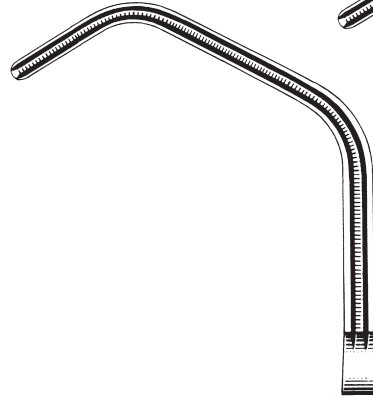

24-425-24-07
26 cm / 10 1/8"

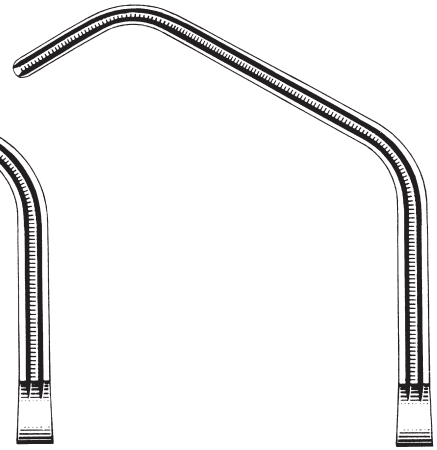

24-425-25-07
26,5 cm / 10 3/8"



1/2

Satinsky
24-425-20-07 -
24-425-27-07



1/4

24-425-26-07
27,5 cm / 10 5/8"



24-425-27-07
28,5 cm / 11 1/8"

Aurikelklemmen

Auricle Clamps
Pinzas para aurícula
Pincès auriculaires
Pinze ventricolari

Gefäßklemmen aus Edelstahl

Stainless Steel Vascular Clamps
Pinzas vasculares acero inoxidable
Pincès vasculaires acier inoxydable
Pinze vascolari acciaio inossidabile

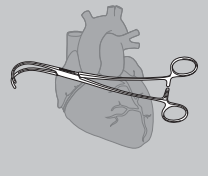

Atrauma

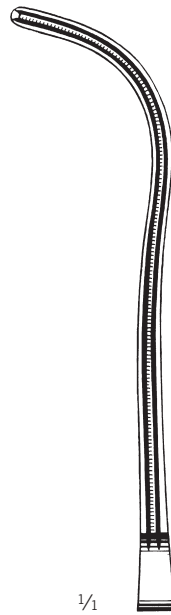

1/1

24-426-01-07
24,5 cm / 9 6/8"

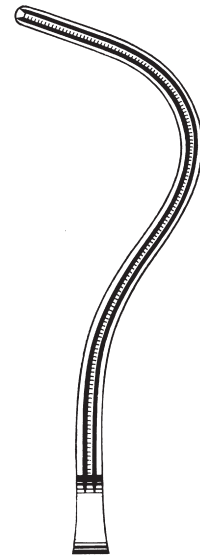

24-426-02-07
24 cm / 9 4/8"



1/2

Harken
24-426-01-07 -
24-426-04-07

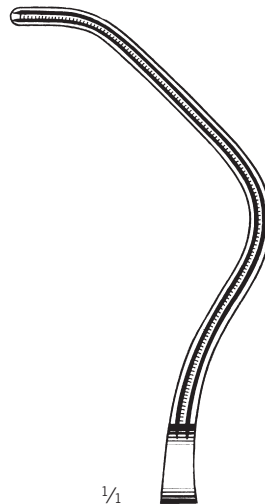

1/1

24-426-03-07
23 cm / 9"



24-426-04-07
23,5 cm / 9 2/8"

Bronchusklemmen

Bronchus Clamps

Pinzas bronquiales

Pinces-clamps à bronches

Pinze per bronchi

Atrauma

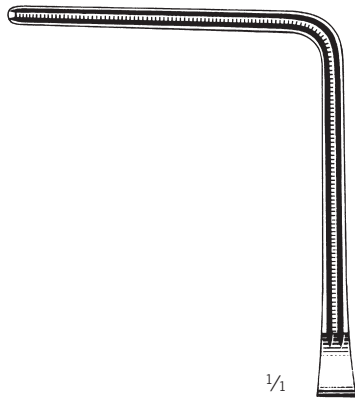

1/1

24-427-23-07
23 cm / 9"

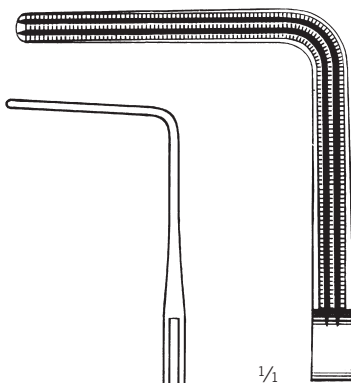

1/1

24-427-25-07
25,5 cm / 10"



1/2

Lees
24-427-23-07 -
24-427-25-07



1/2

Lees
24-429-25-07
26 cm / 10 2/8"

Anastomosenklemmen

Anastomosis Clamps
Pinzas para anastomosis
Pincers-clamps pour anastomose
Pinze per anastomosi

Gefäßklemmen aus Edelstahl

Stainless Steel Vascular Clamps
Pinzas vasculares acero inoxidable
Pincers vasculaires acier inoxydable
Pinze vascolari acciaio inossidabile

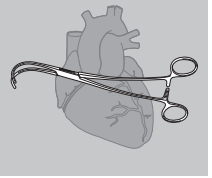

Atrauma

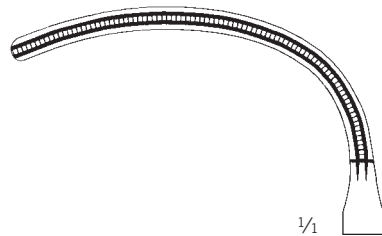

1/1

24-430-00-07
18 cm / 7 1/8"



1/2

Glover
24-430-00-07 -
24-430-01-07

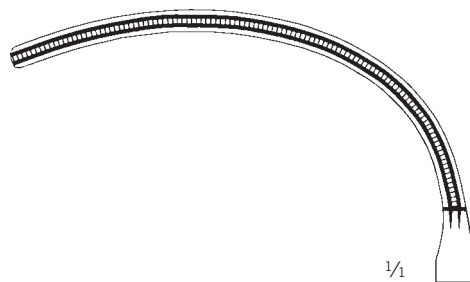

1/1

24-430-01-07
22 cm / 8 5/8"

Gefäßklemmen

Vascular Clamps
Pinzas vasculares
Pincès vasculaires
Pinze vascolari

Atrauma



1/2

Lambert-Kay
24-430-21-07 -
24-430-22-07

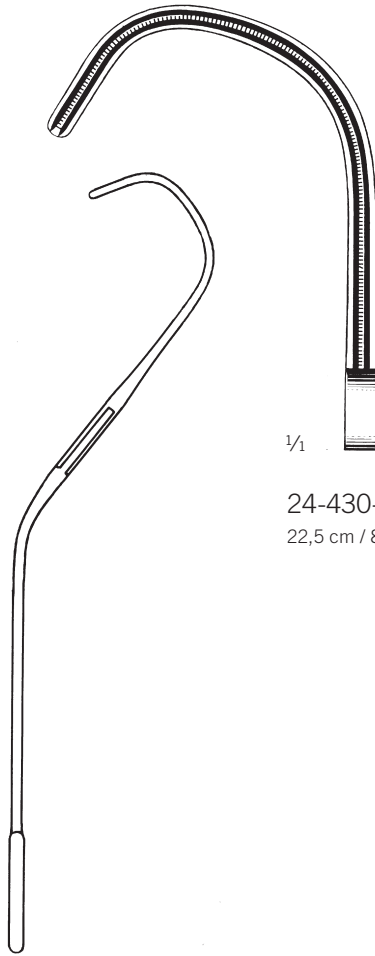

1/1

24-430-21-07
22,5 cm / 8 5/8"



24-430-22-07
20,5 cm / 8 1/8"

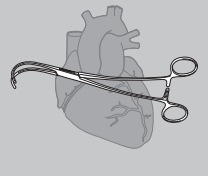

Atrauma 



1/2

De Bakey
24-431-17-07
16,5 cm / 6 1/8"

Aortaklemmen

Aortic Clamps

Pinzas aórticas

Pinces-clamps pour aorte

Pinze per aorta

Atrauma

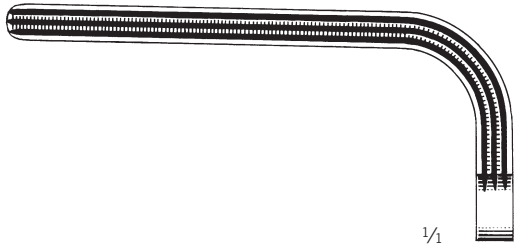

24-432-18-07
18,5 cm / 7 3/8"

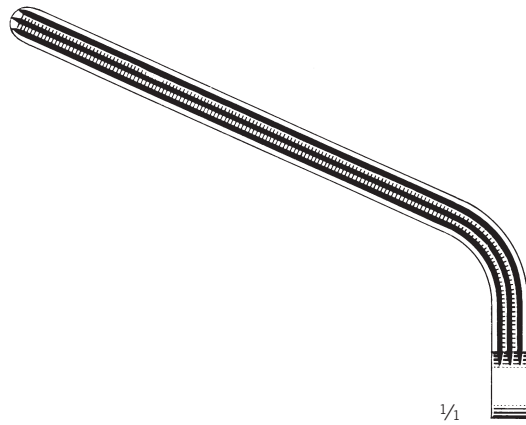

24-432-20-07
20 cm / 8"

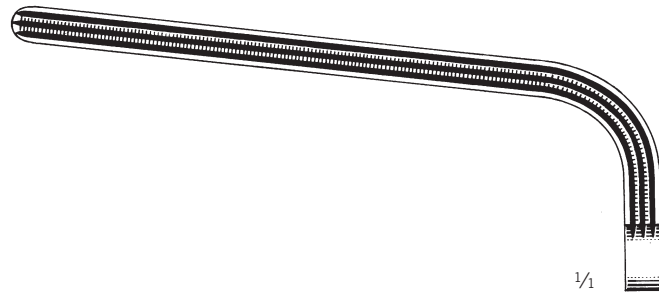

24-432-23-07
26 cm / 10 2/8"



Morris-De Bakey
24-432-18-07 -
24-432-25-07

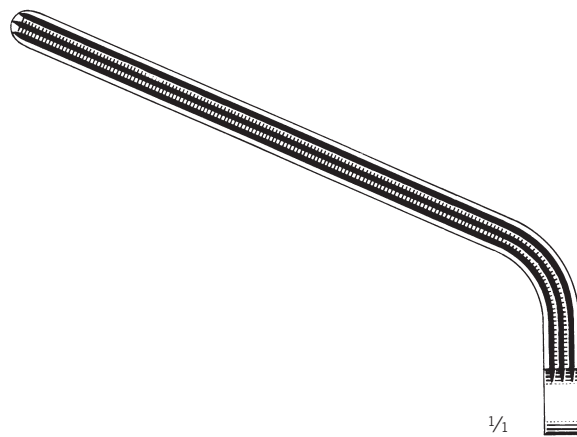

24-432-25-07
27,5 cm / 10 7/8"

Aneurysmaklemmen

Aneurysm Clamps

Pinzas para aneurisma

Pinces-clamps pour anévrisme

Pinze per aneurisma

Gefäßklemmen aus Edelstahl

Stainless Steel Vascular Clamps

Pinzas vasculares acero inoxidable

Pinces vasculaires acier inoxydable

Pinze vascolari acciaio inossidabile

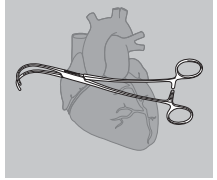

Atrauma



1/2

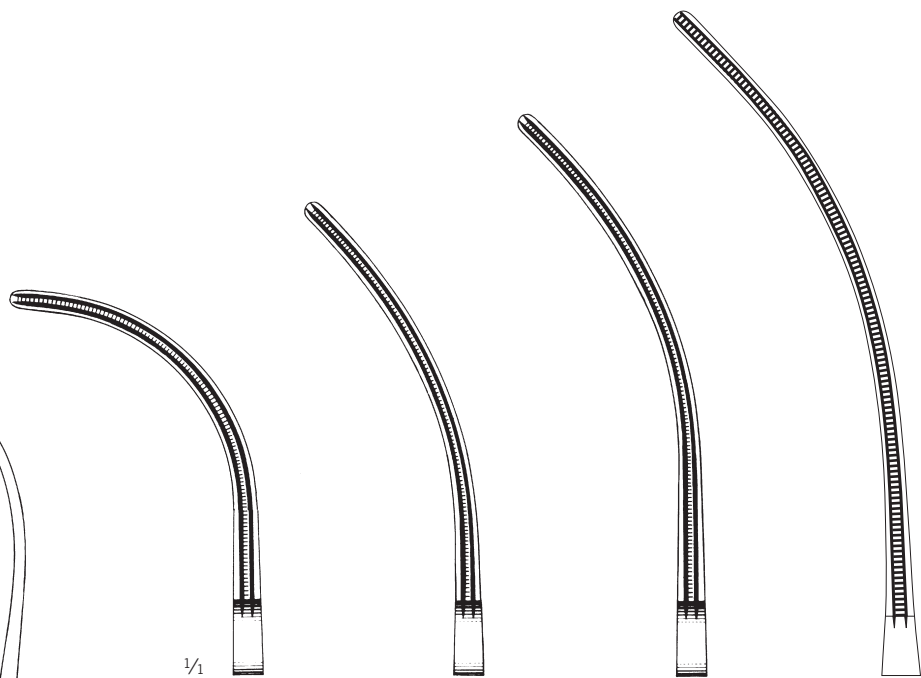

1/1

24-433-23-07
23,5 cm / 9 2/8"

24-433-24-07
24,5 cm / 9 5/8"

24-433-25-07
25,5 cm / 10"

24-433-26-07
26,5 cm / 10 4/8"

De Bakey-Bahnson
24-433-23-07 -
24-433-26-07

Mehrzweck-Gefäßklemmen

Multi purpose Vascular Clamps
Pinzas vasculares de usos múltiples
Pincas vasculaires universelles
Pinze vascolari universali

Atrauma



1/2

Potts
24-434-21-07 -
24-434-31-07

1/1

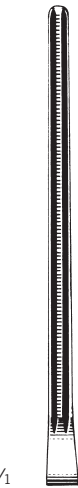

24-434-21-07
21,5 cm / 8 1/8"



24-434-23-07
23,5 cm / 9 2/8"



24-434-27-07
27 cm / 10 5/8"



24-434-31-07
31,5 cm / 12 3/8"

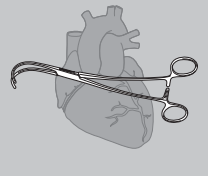

Atrauma



1/2

Potts
24-435-21-07 -
24-435-31-07

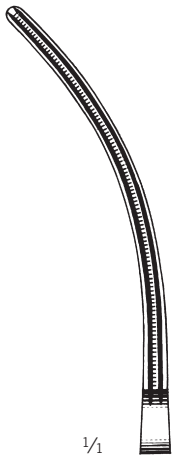

1/1

24-435-21-07
21 cm / 8 2/8"

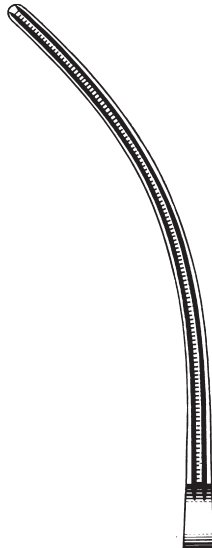

24-435-23-07
23 cm / 9"

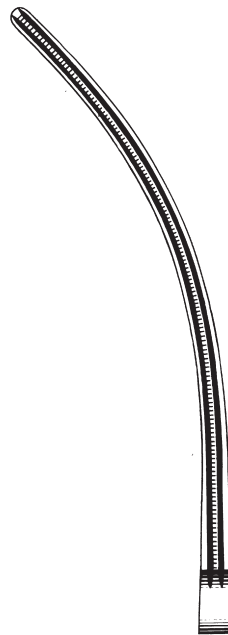

24-435-27-07
26 cm / 10 2/8"

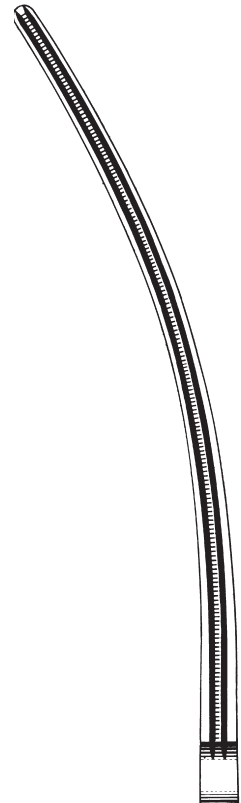

24-435-31-07
31 cm / 12 2/8"

Mehrzweck-Gefäßklemmen

Multi purpose Vascular Clamps
Pinzas vasculares de usos múltiples
Pinces vasculaires universelles
Pinze vascolari universali

Atrauma

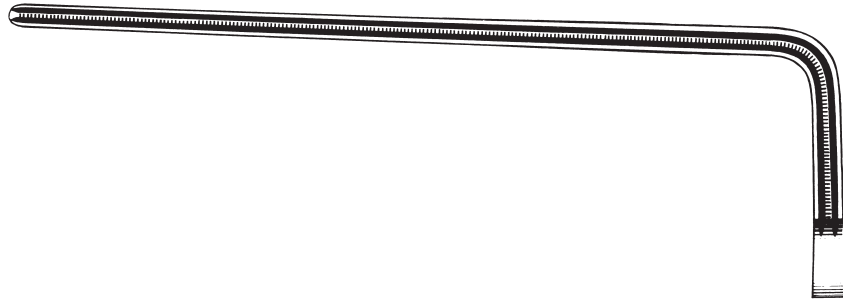

24-436-27-07
27,5 cm / 10 ⁵/₈"

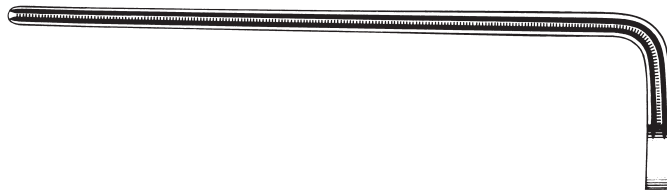

24-436-23-07
23 cm / 9"



24-436-19-07
20 cm / 7 ⁷/₈"

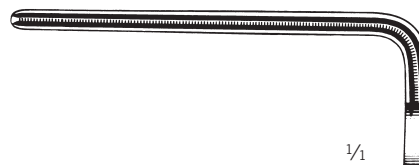

¹/₁
24-436-18-07
19 cm / 7 ⁴/₈"



¹/₂

De Bakey
24-436-18-07 -
24-436-27-07

Gefäßklemmen aus Edelstahl

Stainless Steel Vascular Clamps
Pinzas vasculares acero inoxidable
Pinces vasculaires acier inoxydable
Pinze vascolari acciaio inossidabile

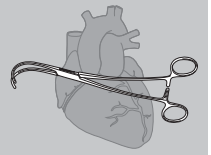

Atrauma

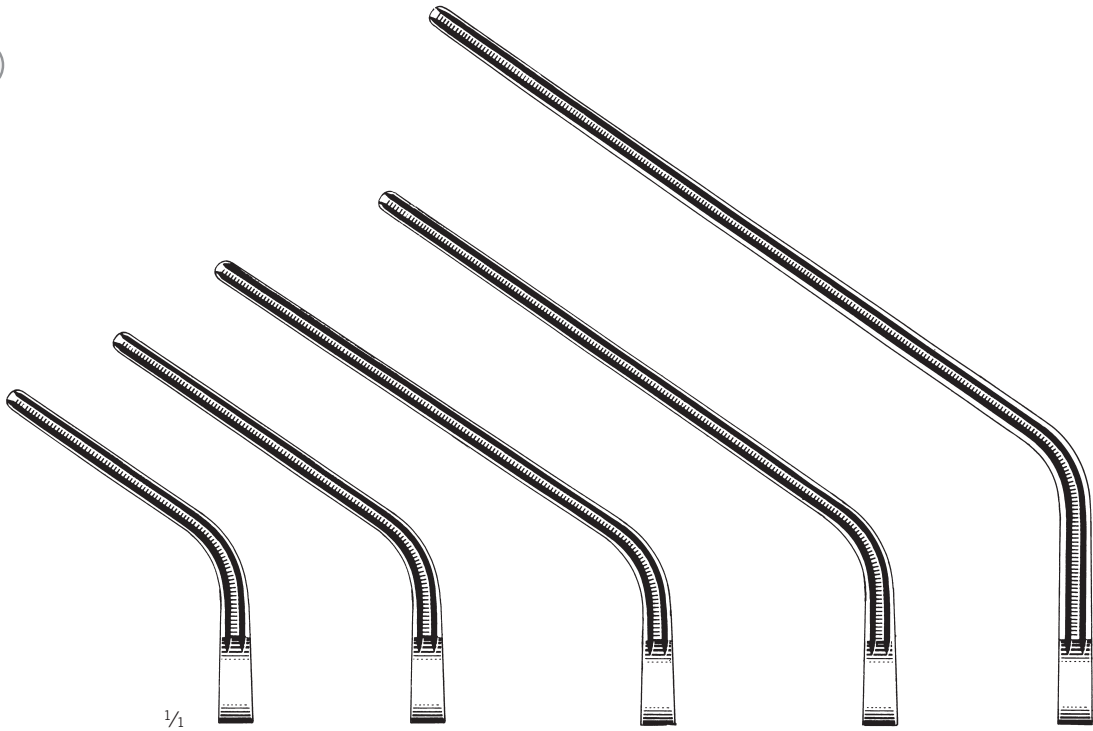

1/1

24-437-18-07
18 cm / 7 1/8"

24-437-20-07
21 cm / 8 2/8"

24-437-21-07
22 cm / 8 6/8"

24-437-25-07
26 cm / 10 2/8"

24-437-29-07
31,5 cm / 12 3/8"



1/2

De Bakey
24-437-18-07 -
24-437-29-07

Gefäßklemmen

Vascular Clamps
Pinzas vasculares
Pincès vasculaires
Pinze vascolari

Atrauma



De Bakey
24-440-17-07
17,5 cm / 6 7/8"



De Bakey
24-441-16-07 -
24-445-15-07

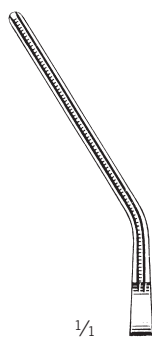

24-441-16-07
16,5 cm / 6 4/8"

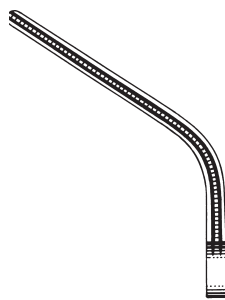

24-443-15-07
16 cm / 6 2/8"

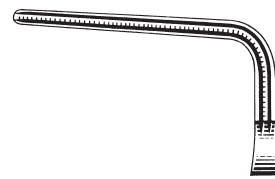

24-445-15-07
15 cm / 5 7/8"

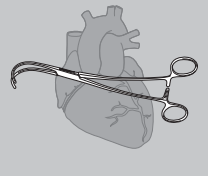

Atrauma



De Bakey
24-447-17-07
16,5 cm / 6 5/8"



Glover
24-449-17-07
17 cm / 6 5/8"



Glover
24-451-17-07 -
24-451-26-07



24-451-17-07
17,5 cm / 6 7/8"



24-451-21-07
21 cm / 8 2/8"



24-451-26-07
26 cm / 10 2/8"

Anastomosenklemmen

Anastomosis Clamps

Pinzas para anastomosis

Pinces pour anastomose

Pinze per anastomosi

Atrauma



1/2

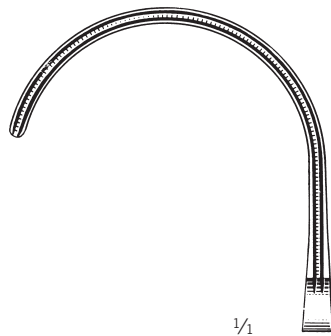

1/1

24-453-16-07

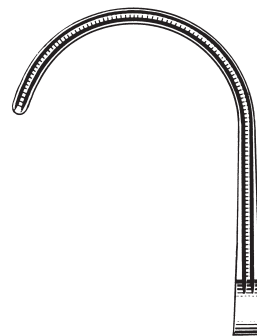

24-455-17-07

De Bakey
24-453-16-07 -
24-455-17-07
16,5 cm / 6 4/8"

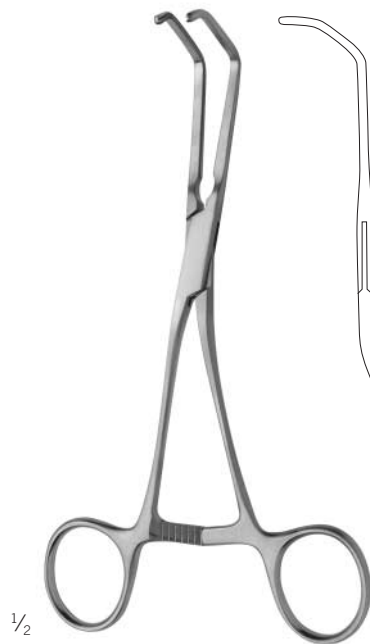

1/2

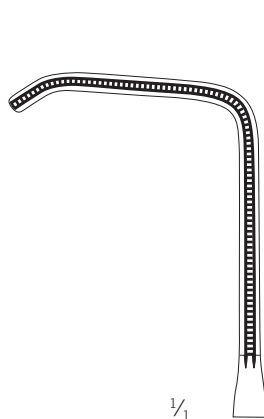
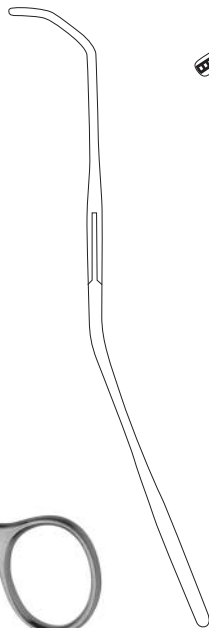

1/1

24-454-16-07
16,5 cm / 6 4/8"

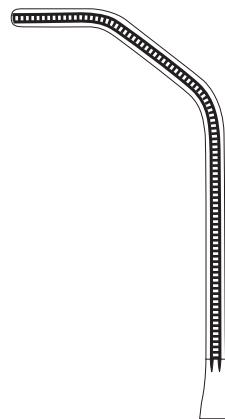

24-454-17-07
17,5 cm / 6 5/8"

De Bakey-Reynolds
24-454-16-07 -
24-454-17-07

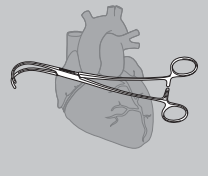

Atrauma



1/2

Derra
 24-456-16-07 -
 24-456-18-07



1/1

Fig. 1
 24-456-16-07
 16,5 cm / 6 4/8"



Fig. 2
 24-456-17-07
 17 cm / 6 5/8"

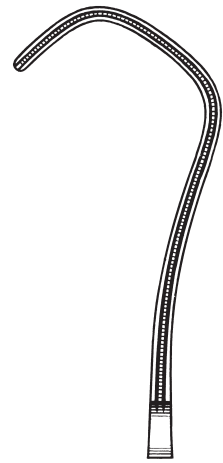
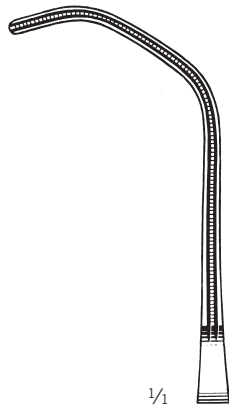

Fig. 3
 24-456-18-07
 17,5 cm / 6 5/8"



1/2

De Bakey-Beck
 24-457-17-07 -
 24-457-21-07



1/1

24-457-17-07
 17 cm / 6 5/8"

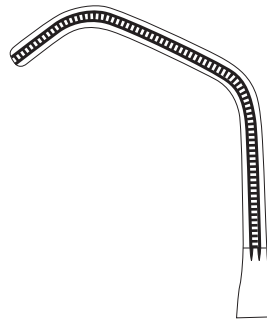

24-457-19-07
 19 cm / 7 4/8"

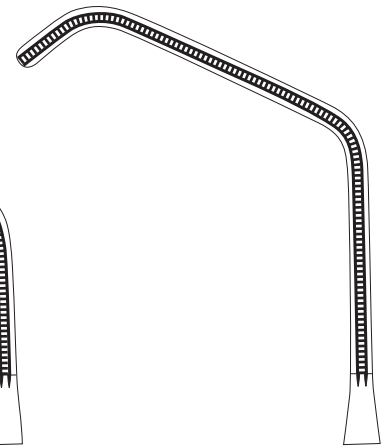

24-457-21-07
 21 cm / 8 2/8"

Anastomosenklemmen

Anastomosis Clamps

Pinzas para anastomosis

Pinces pour anastomose

Pinze per anastomosi

Atrauma



1/2

Alenberg Cobra
24-480-23-07 -
24-480-25-07

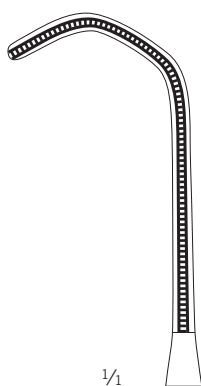

1/1

24-480-23-07
23,5 cm / 9 2/8"

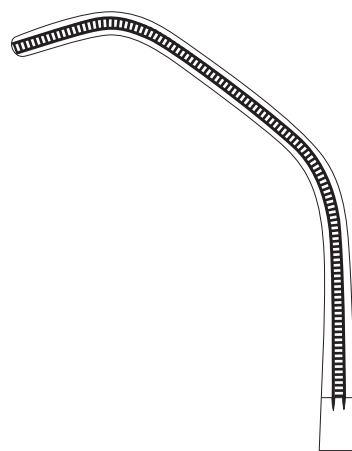

24-480-25-07
24,5 cm / 9 6/8"

Kinder-Gefäßklemmen

Pediatric Vascular Clamps
Pinzas vasculares pediátricas
Pincas vasculaires pédiatriques
Pinze vascolari pediatrice

Gefäßklemmen aus Edelstahl

Stainless Steel Vascular Clamps
Pinzas vasculares acero inoxidable
Pincas vasculaires acier inoxydable
Pinze vascolari acciaio inossidabile

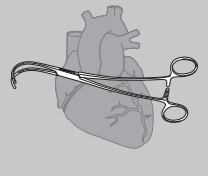

Atrauma



1/1

24-458-10-07
10 cm / 3 7/8"



24-458-11-07
13 cm / 5 1/8"



24-458-12-07
13 cm / 5 1/8"

De Bakey
24-458-10-07 -
24-458-12-07



1/1

24-459-12-07



24-459-13-07

De Bakey
24-459-12-07 -
24-459-13-07
12,5 cm / 4 7/8"

Kinder-Aortaklemmen, Kinder-Gefäßklemmen

Pediatric Aortic Clamps, Pediatric Vascular Clamps

Pinzas aórticas pediátricas, Pinzas vasculares pediátricas

Pinces-clamps pour aorte pédiatriques, Pinces vasculaires pédiatriques

Pinze per aorta pediatrica, Pinze vascolari pediatriche

Atrauma



Subramanian-Miniature
24-559-15-07

16 cm / 6 2/8"

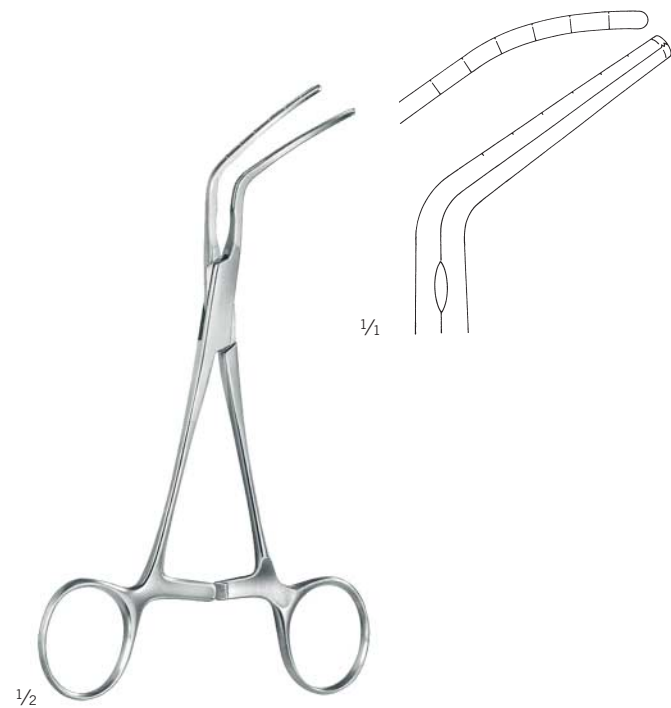

Subramanian
24-561-16-07

16 cm / 6 2/8"

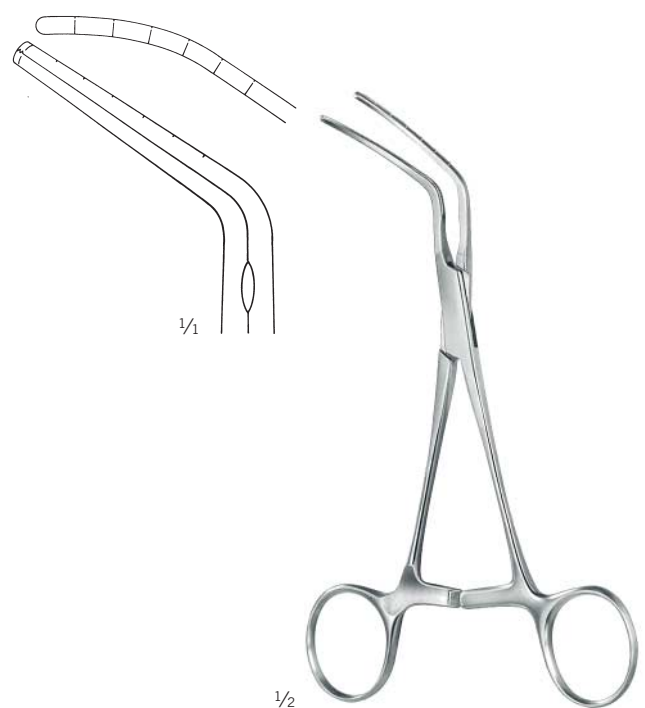

Subramanian
24-563-16-07

16 cm / 6 2/8"

Kinder-Gefäßklemmen

Pediatric Vascular Clamps
 Pinzas vasculares pediátricas
 Pincas vasculaires pédiatriques
 Pinze vascolari pediatriche

Gefäßklemmen aus Edelstahl

Stainless Steel Vascular Clamps
 Pinzas vasculares acero inoxidable
 Pincas vasculaires acier inoxydable
 Pinze vascolari acciaio inossidabile

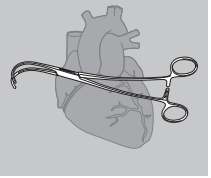

Atrauma



finoLine

Feine chirurgische Instrumente
 Fine surgical instruments
 Instrumentos quirúrgicos, finos
 Instruments chirurgicaux, fins
 Strumenti chirurgici, delicati

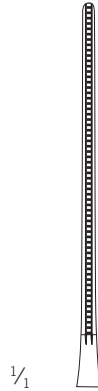

1/1

24-580-01-07
 13,5 cm / 5 3/8"

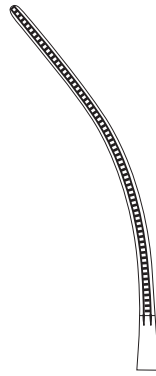

24-580-02-07
 13 cm / 5 1/8"

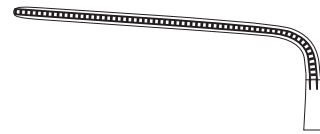

24-580-03-07
 10,5 cm / 4 1/8"

De Bakey
 24-580-01-07 -
 24-580-03-07

feine Zahnung
 delicate serration
 dentado fina
 denture fine
 dentatura delicata

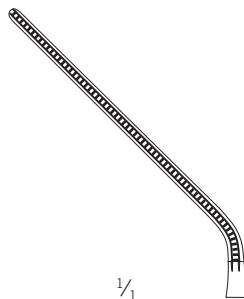
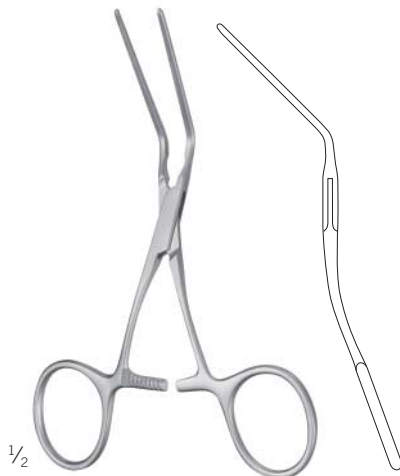

1/1

24-580-04-07
 12 cm / 4 6/8"

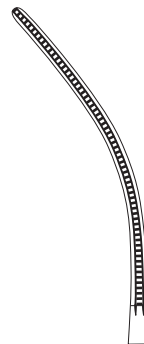

24-580-05-07
 13 cm / 5 1/8"

De Bakey
 24-580-04-07 -
 24-580-05-07

feine Zahnung
 delicate serration
 dentado fina
 denture fine
 dentatura delicata

Kinder-Gefäßklemmen

Pediatric Vascular Clamps

Pinzas vasculares pediátricas

Pinces vasculaires pédiatriques

Pinze vascolari pediatriche

Atrauma

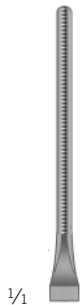

1/1

Fig. 1
24-573-01-07
14 cm / 5 4/8"



Fig. 2
24-573-02-07
14 cm / 5 4/8"



Fig. 3
24-573-03-07
14 cm / 5 4/8"



Fig. 4
24-573-04-07
14 cm / 5 4/8"



Fig. 5
24-573-05-07
14 cm / 5 4/8"



Fig. 6
24-573-06-07
13 cm / 5"



1/1

Fig. 7
24-573-07-07
13 cm / 5"



Fig. 8
24-573-08-07
14 cm / 5 4/8"



Fig. 9
24-573-09-07
13 cm / 5"



Fig. 10
24-573-10-07
14 cm / 5 4/8"



Fig. 11
24-573-11-07
14 cm / 5 4/8"

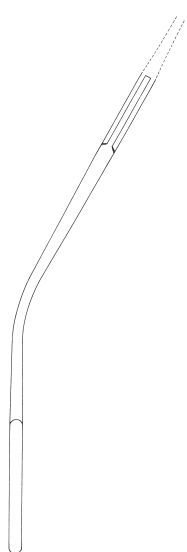

Fig. 12
24-573-12-07
14 cm / 5 4/8"



1/2

De Bakey baby
24-573-01-07 -
24-573-15-07



1/1

Fig. 13
24-573-13-07
14 cm / 5 4/8"



Fig. 14
24-573-14-07
14 cm / 5 4/8"



Fig. 15
24-573-15-07
14 cm / 5 4/8"

Gefäßklemmen aus Edelstahl

Stainless Steel Vascular Clamps
Pinzas vasculares acero inoxidable
Pinces vasculaires acier inoxydable
Pinze vascolari acciaio inossidabile

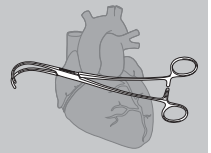

Atrauma



1/2

1/1

De Bakey baby
24-588-16-07
16,5 cm / 6 4/8"



1/2

1/1

De Bakey baby
24-589-16-07
16,5 cm / 6 4/8"



1/2

1/1

De Bakey baby
24-590-16-07
15,5 cm / 6"



1/2

1/1

De Bakey baby
24-591-15-07
15,5 cm / 6"



1/2

1/1

De Bakey baby
24-592-16-07
16 cm / 6 2/8"

Mehrzweck-Gefäßklemmen

Multi purpose Vascular Clamps
 Pinzas vasculares de usos múltiples
 Pincas vasculaires universelles
 Pinze vascolari universali

Atrauma

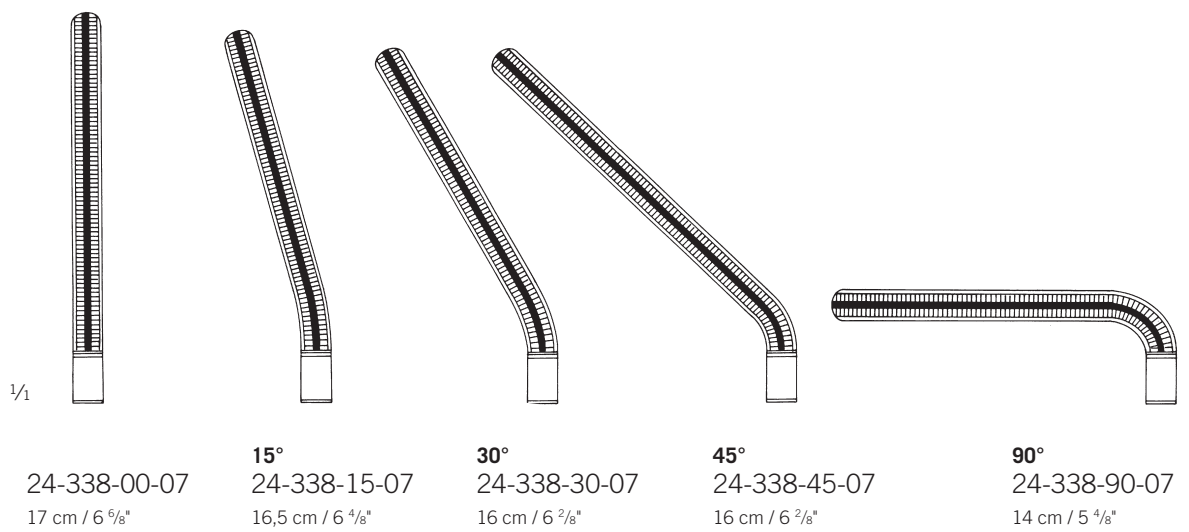
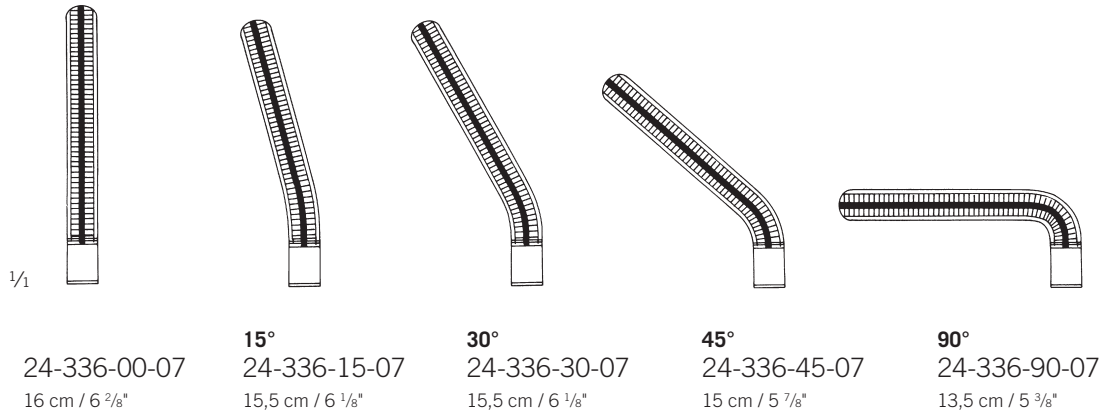

Dardik
 24-336-00-07 -
 24-338-90-07

Katheterklemmen

Catheter Clamps

Pinzas para catéteres

Pinces pour sondes

Pinze per cateteri

Gefäßklemmen aus Edelstahl

Stainless Steel Vascular Clamps

Pinzas vasculares acero inoxidable

Pinces vasculaires acier inoxydable

Pinze vascolari acciaio inossidabile

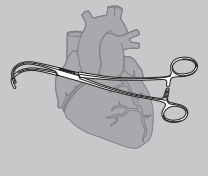

Atrauma

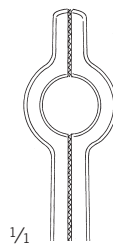

1/1

24-350-00-07

17 cm / 6 5/8"
20 Charr.



24-350-01-07

17 cm / 6 5/8"
24 Charr.

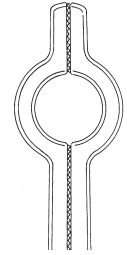

24-350-02-07

17 cm / 6 5/8"
26 Charr.

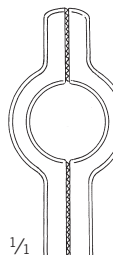

1/1

24-350-03-07

20 cm / 7 7/8"
28 Charr.



24-350-04-07

20 cm / 7 7/8"
30 Charr.

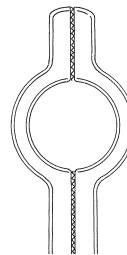

24-350-05-07

20 cm / 7 7/8"
32 Charr.



1/1

24-350-07-07

20 cm / 7 7/8"
36 Charr.



24-350-08-07

20 cm / 7 7/8"
38 Charr.



24-350-09-07

20 cm / 7 7/8"
40 Charr.

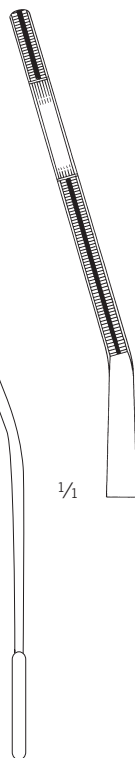

1/1

1/2

Cooley
24-350-00-07 -
24-350-09-07

Aortaklemmen

Aortic Clamps

Pinzas aórticas

Pinces-clamps pour aorte

Pinze per aorta

Atrauma



Cooley
24-354-26-07
26 cm / 10 2/8"

Gefäßklemmen

Vascular Clamps
Pinzas vasculares
Pinces vasculaires
Pinze vascolari

Gefäßklemmen aus Edelstahl

Stainless Steel Vascular Clamps
Pinzas vasculares acero inoxidable
Pinces vasculaires acier inoxydable
Pinze vascolari acciaio inossidabile

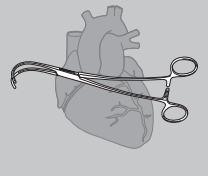

Atrauma



1/2

Cooley
24-354-19-07 -
24-354-34-07

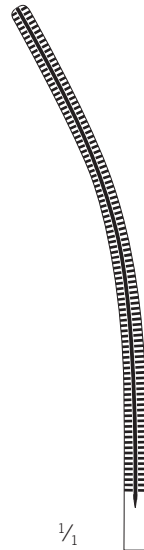

1/1

24-354-19-07
19 cm / 7 4/8"

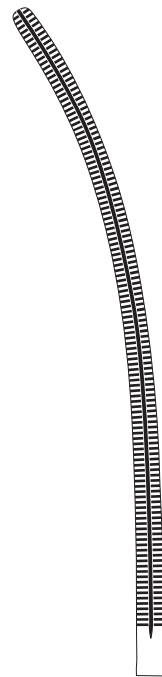

24-354-27-07
26,5 cm / 10 4/8"



24-354-34-07
33,5 cm / 13 4/8"

Gefäßklemmen

Vascular Clamps
Pinzas vasculares
Pinces vasculaires
Pinze vascolari

Atrauma

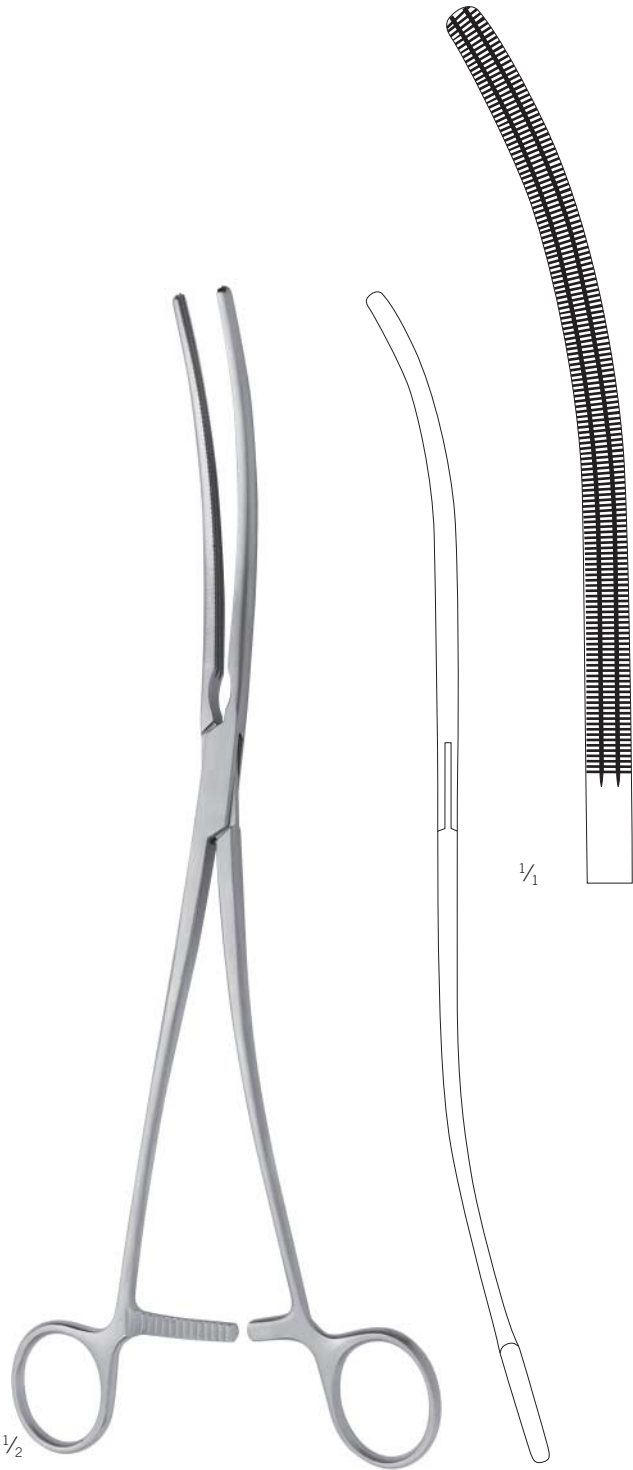

Cooley
24-354-32-07
31,5 cm / 12 2/8"

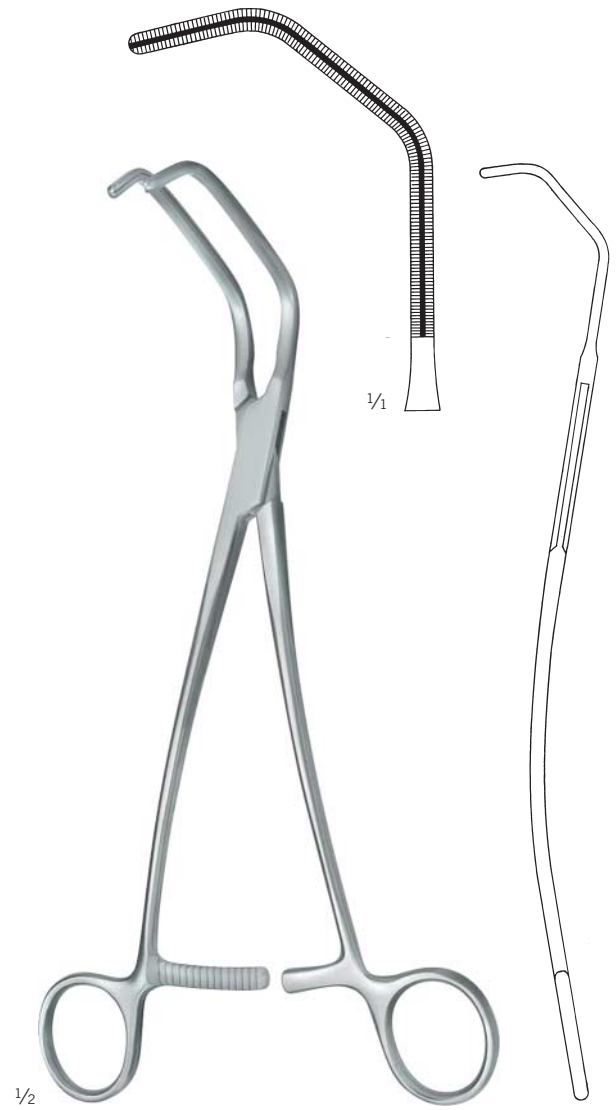

Cooley
24-420-25-07
25 cm / 9 7/8"

Kinder-Gefäßklemmen

Pediatric Vascular Clamps
 Pinzas vasculares pediátricas
 Pincas vasculaires pédiatriques
 Pinze vascolari pediatriche

Gefäßklemmen aus Edelstahl

Stainless Steel Vascular Clamps
 Pinzas vasculares acero inoxidable
 Pincas vasculaires acier inoxydable
 Pinze vascolari acciaio inossidabile

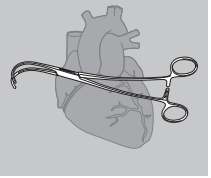

Atrauma

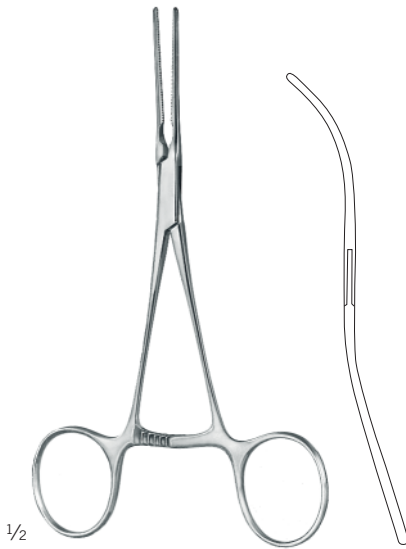

1/2

Cooley
 24-466-01-07 -
 24-466-06-07

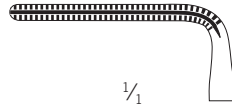

1/1

24-466-00-07
 11,5 cm / 4 4/8"



24-466-01-07
 14,5 cm / 5 6/8"

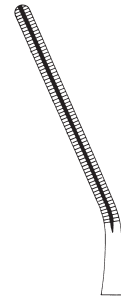

24-466-02-07
 14,5 cm / 5 6/8"

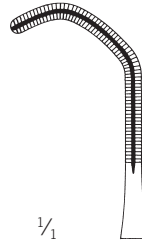

1/1

24-466-04-07
 14 cm / 5 4/8"



24-466-05-07
 14,5 cm / 5 6/8"

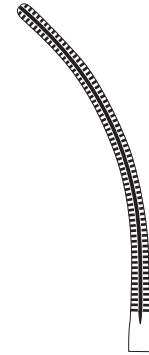

24-466-06-07
 12,5 cm / 4 7/8"



1/2

Cooley
 24-466-03-07
 14,5 cm / 5 6/8"

Anastomosenklemmen, Mehrzweck-Gefäßklemmen

Anastomosis Clamps, Multi purpose Vascular Clamps

Pinzas para anastomosis, Pinzas vasculares de usos múltiples

Pinces-clamps pour anastomose, Pinces vasculaires universelles

Pinze per anastomosi, Pinze vascolari universali

Atrauma

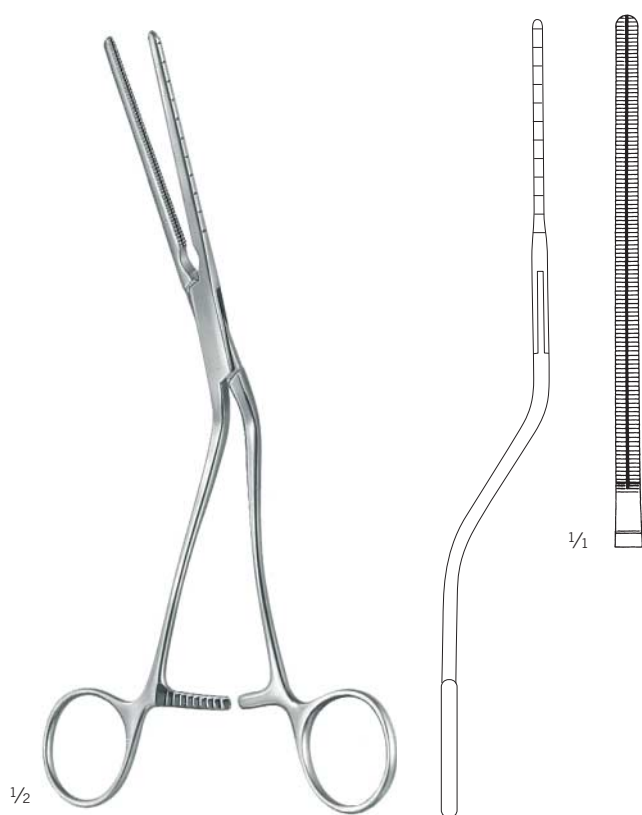

Cooley
24-467-21-07

22 cm / 8 5/8"

Iliacaklemme
Iliac Clamp
Pinza para iliaca
Pince-clamps iliaque
Pinza iliaca



Cooley
24-468-17-07

17 cm / 6 5/8"

Gefäßklemmen aus Edelstahl

Stainless Steel Vascular Clamps
Pinzas vasculares acero inoxidable
Pinces vasculaires acier inoxydable
Pinze vascolari acciaio inossidabile

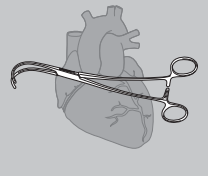

Atrauma

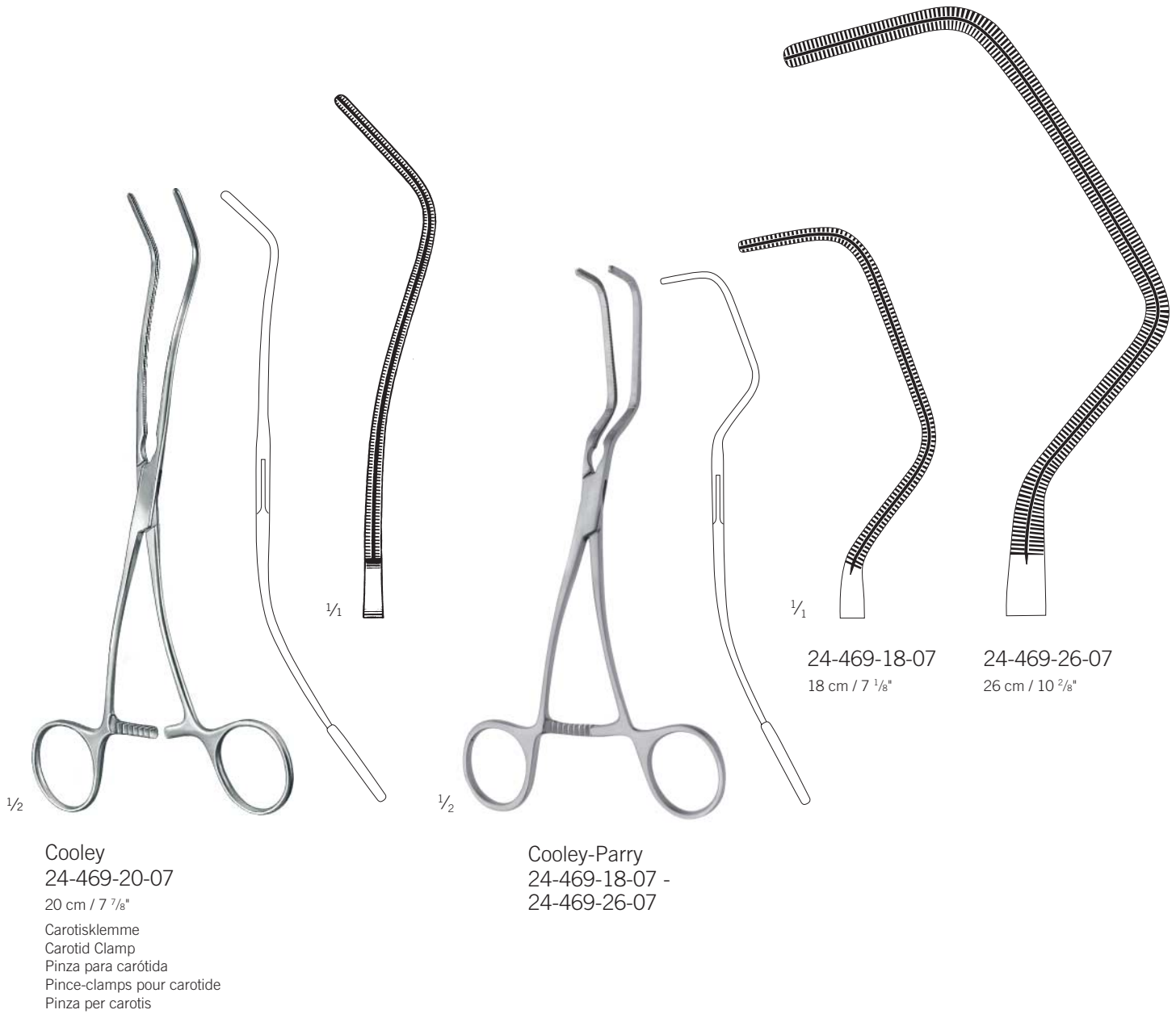

1/2

1/1

1/2

1/1

24-469-18-07
18 cm / 7 1/8"

24-469-26-07
26 cm / 10 2/8"

Cooley
24-469-20-07
20 cm / 7 7/8"

Cooley-Parry
24-469-18-07 -
24-469-26-07

Carotisklemme
Carotid Clamp
Pinza para carótida
Pince-clamps pour carotide
Pinza per carotis

Anastomosenklemmen, Mehrzweck-Gefäßklemmen

Anastomosis Clamps, Multi purpose Vascular Clamps

Pinzas para anastomosis, Pinzas vasculares de usos múltiples

Pinces-clamps pour anastomose, Pinces vasculaires universelles

Pinze per anastomosi, Pinze vascolari universali

Atrauma



1/2

Cooley
24-470-17-07
17 cm / 6 5/8"



1/2

Cooley
24-471-16-07
16 cm / 6 2/8"

1/1

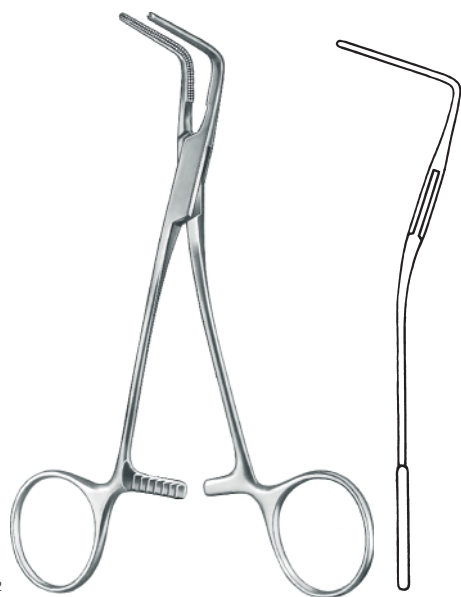

1/2

Cooley
24-472-15-07 -
24-472-17-07

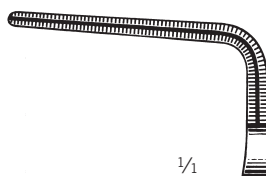

1/1

24-472-15-07
14,5 cm / 5 5/8"

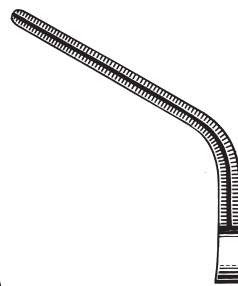

24-472-16-07
16 cm / 6 2/8"

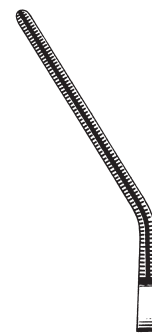

24-472-17-07
16,5 cm / 6 5/8"

Anastomosenklemmen

Anastomosis Clamps
Pinzas para anastomosis
Pinces-clamps pour anastomose
Pinze per anastomosi

Gefäßklemmen aus Edelstahl

Stainless Steel Vascular Clamps
Pinzas vasculares acero inoxidable
Pinces vasculaires acier inoxydable
Pinze vascolari acciaio inossidabile

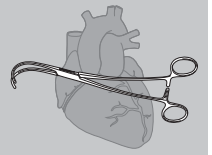

Atrauma



Cooley
24-473-17-07
17 cm / 6 5/8"

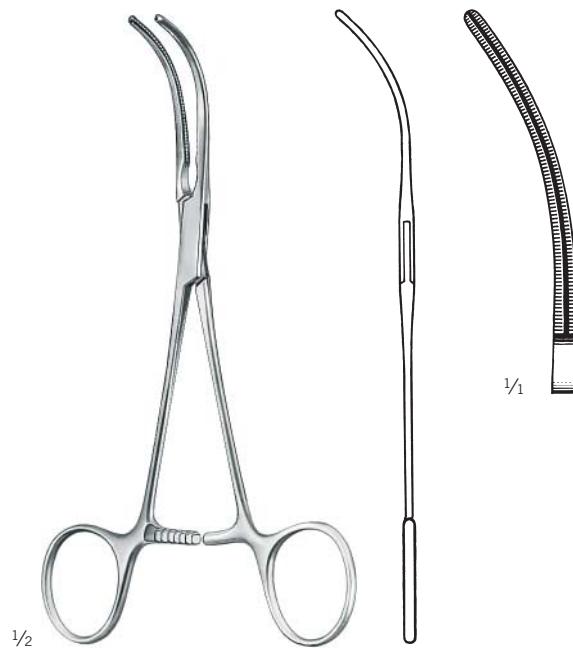

Cooley
24-474-17-07
17 cm / 6 5/8"

Anastomosenklemmen

Anastomosis Clamps

Pinzas para anastomosis

Pinces-clamps pour anastomose

Pinze per anastomosi

Atrauma

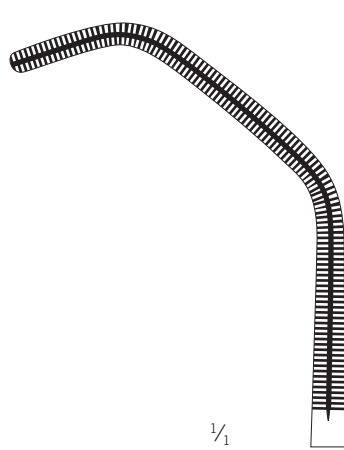

$\frac{1}{1}$

24-475-26-07
26,5 cm / 10 $\frac{4}{8}$ "

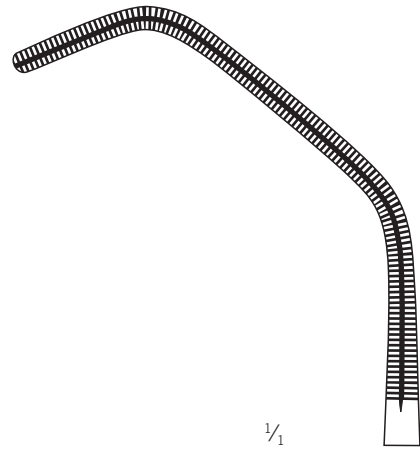

$\frac{1}{1}$

24-475-27-07
26,5 cm / 10 $\frac{4}{8}$ "

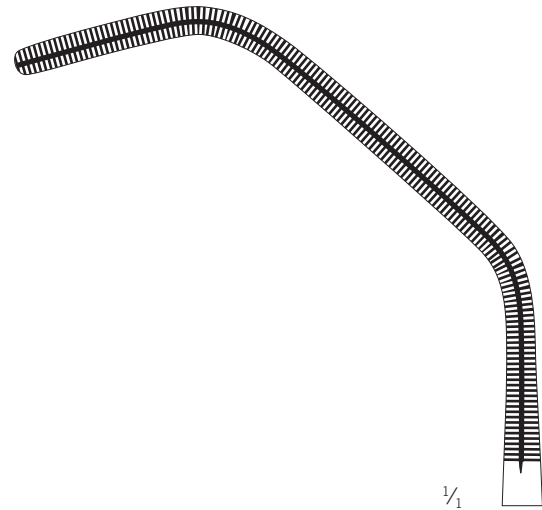

$\frac{1}{1}$

24-475-28-07
27,5 cm / 10 $\frac{6}{8}$ "



$\frac{1}{2}$

Cooley
24-475-26-07 -
24-475-28-07

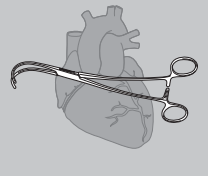

Atrauma

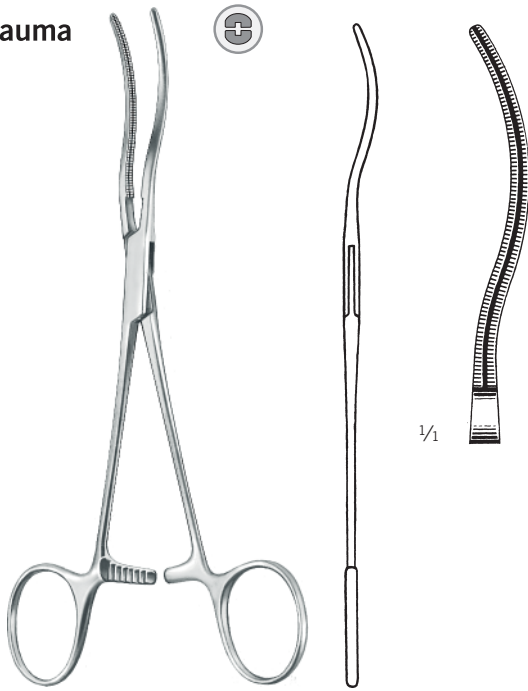

Cooley
 24-476-17-07
 17,5 cm / 6 7/8"



1/2

Cooley
 24-477-16-07 -
 24-477-17-07
 16,5 cm / 6 4/8"

1/1

1/1

24-477-16-07

24-477-17-07

Anastomosenklemmen

Anastomosis Clamps

Pinzas para anastomosis

Pinces-clamps pour anastomose

Pinze per anastomosi

Atrauma



1/2

Cooley-Derra
24-478-16-07 -
24-478-21-07

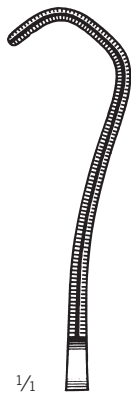

1/1

24-478-16-07
16,5 cm / 6 1/8"

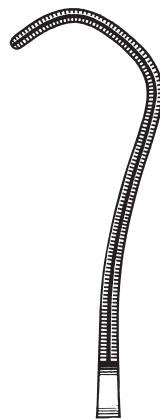

24-478-17-07
17 cm / 6 5/8"

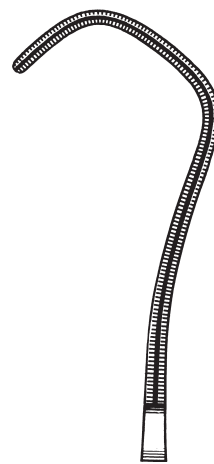

24-478-18-07
17,5 cm / 6 7/8"

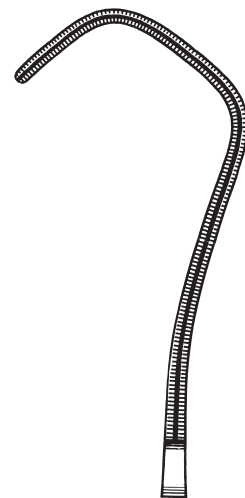

24-478-21-07
21 cm / 8 1/8"

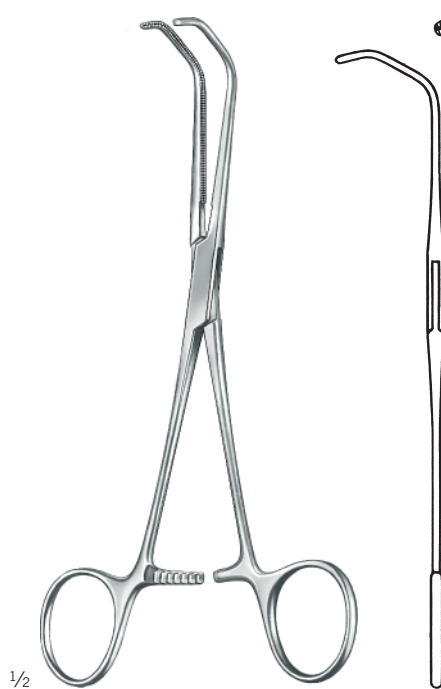

1/2

Cooley-Beck
24-479-17-07
17 cm / 6 5/8"

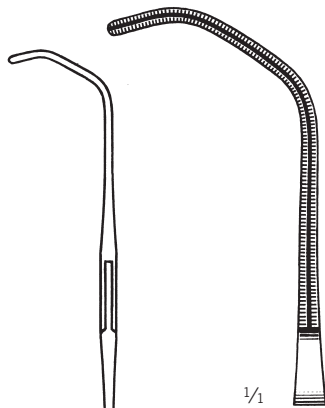

1/1

Kinder-Gefäßklemmen

Pediatric Vascular Clamps
 Pinzas vasculares pediátricas
 Pincas vasculaires pédiatriques
 Pinze vascolari pediatriche

Gefäßklemmen aus Edelstahl

Stainless Steel Vascular Clamps
 Pinzas vasculares acero inoxidable
 Pincas vasculaires acier inoxydable
 Pinze vascolari acciaio inossidabile

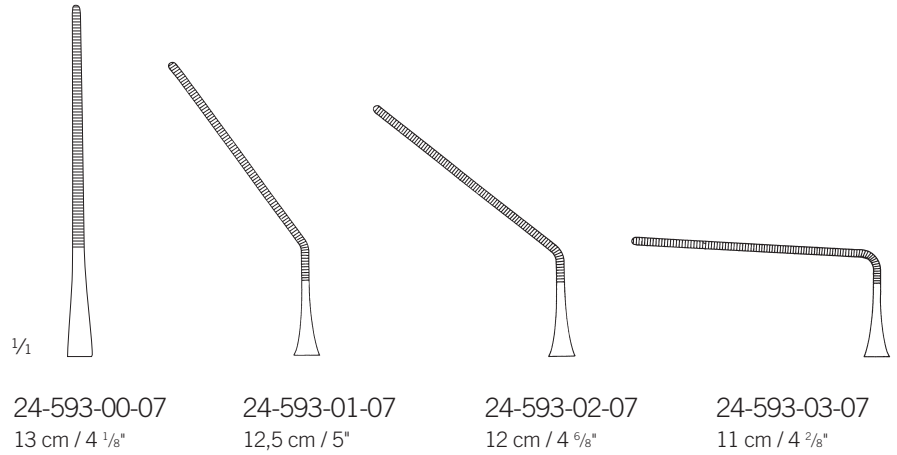
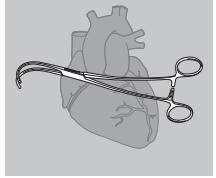

Castañeda
 24-593-00-07 -
 24-597-12-07

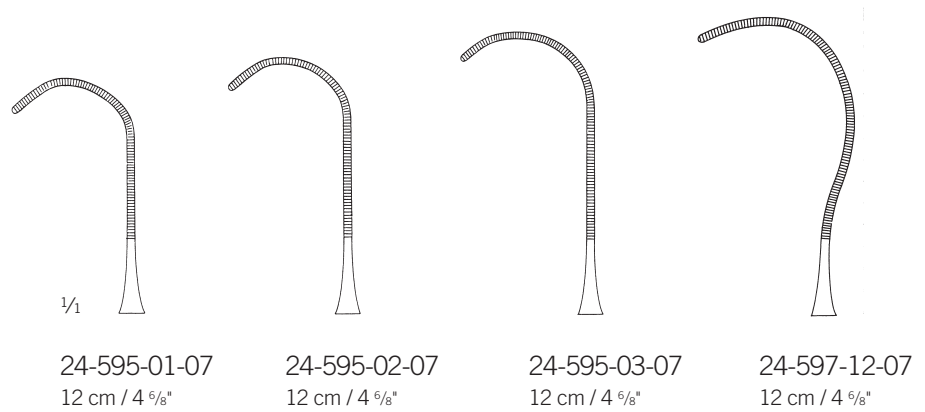

Nummern-Index

Index of order numbers

Índice de números de referencia

Index numérique des références de commande

Elenco dei codici

24

24-317-23-074	24-408-23-0717	24-435-27-0739	24-478-16-0764
24-319-21-074	24-409-16-0718	24-435-31-0739	24-478-17-0764
24-336-00-0752	24-411-19-0718	24-436-18-0740	24-478-18-0764
24-336-15-0752	24-411-20-0719	24-436-19-0740	24-478-21-0764
24-336-30-0752	24-413-18-0720	24-436-23-0740	24-479-17-0764
24-336-45-0752	24-413-19-0720	24-436-27-0740	24-480-23-0746
24-336-90-0752	24-413-20-0720	24-437-18-0741	24-480-25-0746
24-338-00-0752	24-414-15-0721	24-437-20-0741	24-559-15-0748
24-338-15-0752	24-414-18-0721	24-437-21-0741	24-561-16-0748
24-338-30-0752	24-415-15-0722	24-437-25-0741	24-563-16-0748
24-338-45-0752	24-415-18-0722	24-437-29-0741	24-573-01-0750
24-338-90-0752	24-416-20-0722	24-440-17-0742	24-573-02-0750
24-340-18-075	24-417-26-0723	24-441-16-0742	24-573-03-0750
24-341-17-075	24-417-27-0723	24-443-15-0742	24-573-04-0750
24-341-18-075	24-417-31-0723	24-445-15-0742	24-573-05-0750
24-341-19-075	24-417-33-0723	24-447-17-0743	24-573-06-0750
24-342-14-076	24-418-28-0724	24-449-17-0743	24-573-07-0750
24-342-16-076	24-419-30-0724	24-451-17-0743	24-573-08-0750
24-342-18-076	24-420-25-0756	24-451-21-0743	24-573-09-0750
24-343-18-077	24-420-27-0725	24-451-26-0743	24-573-10-0750
24-343-19-077	24-421-24-0726	24-453-16-0744	24-573-11-0750
24-344-16-078	24-422-24-0726	24-454-16-0744	24-573-12-0750
24-344-17-078	24-423-25-0727	24-454-17-0744	24-573-13-0750
24-344-18-078	24-423-26-0727	24-455-17-0744	24-573-14-0750
24-344-20-078	24-424-01-0728	24-456-16-0745	24-573-15-0750
24-344-24-079	24-424-02-0728	24-456-17-0745	24-580-01-0749
24-344-27-079	24-424-03-0729	24-456-18-0745	24-580-02-0749
24-344-30-0710	24-424-04-0729	24-457-17-0745	24-580-03-0749
24-345-18-0711	24-425-00-0729	24-457-19-0745	24-580-04-0749
24-347-18-0711	24-425-20-0730	24-457-21-0745	24-580-05-0749
24-349-17-0711	24-425-24-0730	24-458-10-0747	24-588-16-0751
24-349-20-0712	24-425-25-0730	24-458-11-0747	24-589-16-0751
24-350-00-0753	24-425-26-0730	24-458-12-0747	24-590-16-0751
24-350-01-0753	24-425-27-0730	24-459-12-0747	24-591-15-0751
24-350-02-0753	24-426-01-0731	24-459-13-0747	24-592-16-0751
24-350-03-0753	24-426-02-0731	24-466-00-0757	24-593-00-0765
24-350-04-0753	24-426-03-0731	24-466-01-0757	24-593-01-0765
24-350-05-0753	24-426-04-0731	24-466-02-0757	24-593-02-0765
24-350-07-0753	24-427-23-0732	24-466-03-0757	24-593-03-0765
24-350-08-0753	24-427-25-0732	24-466-04-0757	24-595-01-0765
24-350-09-0753	24-429-25-0732	24-466-05-0757	24-595-02-0765
24-352-22-0713	24-430-00-0733	24-466-06-0757	24-595-03-0765
24-352-25-0713	24-430-01-0733	24-467-21-0758	24-597-12-0765
24-352-31-0713	24-430-21-0734	24-468-17-0758	
24-353-25-0714	24-430-22-0734	24-469-18-0759	
24-354-19-0755	24-431-17-0735	24-469-20-0759	
24-354-26-0754	24-432-18-0736	24-469-26-0759	
24-354-27-0755	24-432-20-0736	24-470-17-0760	
24-354-32-0756	24-432-23-0736	24-471-16-0760	
24-354-34-0755	24-432-25-0736	24-472-15-0760	
24-400-21-0715	24-433-23-0737	24-472-16-0760	
24-400-22-0715	24-433-24-0737	24-472-17-0760	
24-401-21-0715	24-433-25-0737	24-473-17-0761	
24-401-22-0715	24-433-26-0737	24-474-17-0761	
24-403-21-0716	24-434-21-0738	24-475-26-0762	
24-403-22-0716	24-434-23-0738	24-475-27-0762	
24-405-22-0717	24-434-27-0738	24-475-28-0762	
24-407-22-0717	24-434-31-0738	24-476-17-0763	
24-408-19-0717	24-435-21-0739	24-477-16-0763	
	24-435-23-0739	24-477-17-0763	

Gefäßklemmen

Vascular Clamps
Pinzas vasculares
Pincès vasculaires
Pinze vascolari



KLS Martin Group

Karl Leibinger Medizintechnik GmbH & Co. KG
78570 Mühlheim · Germany
Tel. +49 7463 838-0
info@klsmartin.com

KLS Martin GmbH + Co. KG
79224 Umkirch · Germany
Tel. +49 7665 9802-0
info@klsmartin.com

Stuckenbrock Medizintechnik GmbH
78532 Tuttlingen · Germany
Tel. +49 7461 165880
verwaltung@stuckenbrock.de

Rudolf Buck GmbH
78570 Mühlheim · Germany
Tel. +49 7463 99516-30
info@klsmartin.com

KLS Martin France SARL
68200 Mulhouse · France
Tel. +33 3 8951 3150
france@klsmartin.com

Martin Italia S.r.l.
20864 Agrate Brianza (MB) · Italy
Tel. +39 039 605 6731
italia@klsmartin.com

Martin Nederland/Marned B.V.
1271 AG Huizen · The Netherlands
Tel. +31 35 523 4538
nederland@klsmartin.com

KLS Martin UK Ltd.
Reading RG1 3EU · United Kingdom
Tel. +44 1189 000 570
uk@klsmartin.com

Nippon Martin K.K.
Osaka 541-0046 · Japan
Tel. +81 6 62 289075
nippon@klsmartin.com

KLS Martin L.P.
Jacksonville, FL 32246 · USA
Tel. +1 904 641 7746
usa@klsmartin.com

KLS Martin do Brasil Ltda.
CEP 04.531-011 São Paulo · Brazil
Tel.: +55 11 3554 2299
brazil@klsmartin.com

KLS Martin Australia Pty Limited
Artarmon NSW 2064 · Australia
Tel.: +61 2 9439 5316
australia@klsmartin.com

KLS Martin Malaysia Sdn. Bhd.
10200 Penang · Malaysia
Tel. +604 263 2566
malaysia@klsmartin.com

Gebrüder Martin GmbH & Co. KG
Representative Office
121471 Moscow · Russia
Tel. +7 499 792-76-19
russia@klsmartin.com

Gebrüder Martin GmbH & Co. KG
Representative Office
201203 Shanghai · China
Tel. +86 21 2898 6611
china@klsmartin.com

Gebrüder Martin GmbH & Co. KG
Representative Office
Dubai · United Arab Emirates
Tel. +971 4 454 1655
middleeast@klsmartin.com

1923 | SURGICAL
2013 | INNOVATION
YEARS

Gebrüder Martin GmbH & Co. KG
A company of the KLS Martin Group
KLS Martin Platz 1 · 78532 Tuttlingen · Germany
Postfach 60 · 78501 Tuttlingen · Germany
Tel. +49 7461 706-0 · Fax +49 7461 706-193
info@klsmartin.com · www.klsmartin.com

