



Arterien-, Präparier-
und Peripherieklemmen

Haemostatic-, Dissecting
and Peripheral Forceps

Pinzas hemostáticas, de disección
y periféricas

Pinces hémostatiques, à dissection
et périphériques

Pinze emostatiche, da dissezione
e periferiche

Arterienklemmen

Haemostatic Forceps
Pinzas hemostáticas
Pincès hémostatiques
Pinze emostatiche

Atrauma



1/1

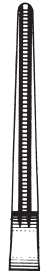

24-300-16-07



24-301-16-07



1/1



24-302-15-07

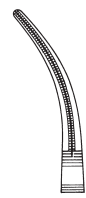

24-303-15-07

De Bakey-Rankin
24-300-16-07 -
24-301-16-07
16 cm / 6 2/8"

De Bakey-Mosquito
24-302-15-07 -
24-303-15-07
15 cm / 5 7/8"



1/1



24-438-12-07



24-439-12-07

De Bakey-Mosquito
24-438-12-07 -
24-439-12-07
12,5 cm / 4 7/8"

Arterien-, Präparier- und Peripherieklemmen

Haemostatic-, Dissecting and Peripheral Forceps
 Pinzas hemostáticas, de disección y periféricas
 Pincas hémostatiques, à dissection et périphériques
 Pinze emostatiche, da dissezione e periferiche



Atrauma



1/2

De Bakey-Pean
 24-438-14-07 -
 24-438-20-07

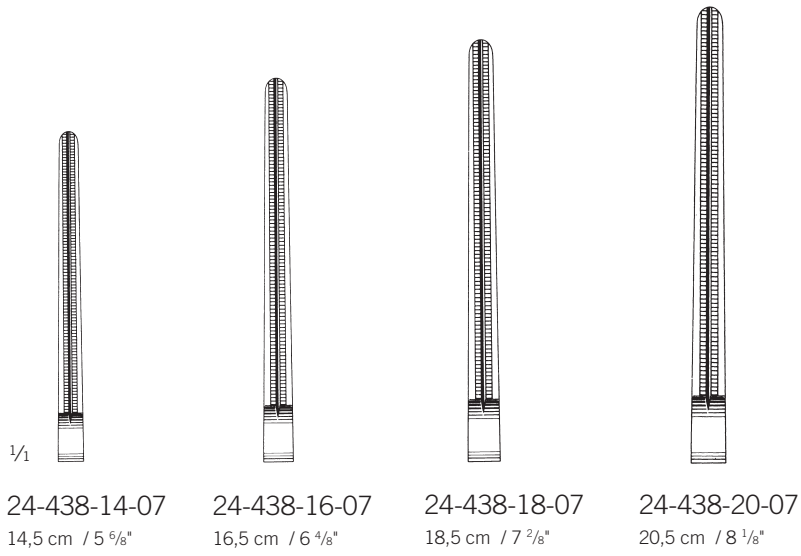

24-438-14-07
 14,5 cm / 5 9/8"

24-438-16-07
 16,5 cm / 6 4/8"

24-438-18-07
 18,5 cm / 7 2/8"

24-438-20-07
 20,5 cm / 8 1/8"



1/2

De Bakey-Pean
 24-439-14-07 -
 24-439-20-07

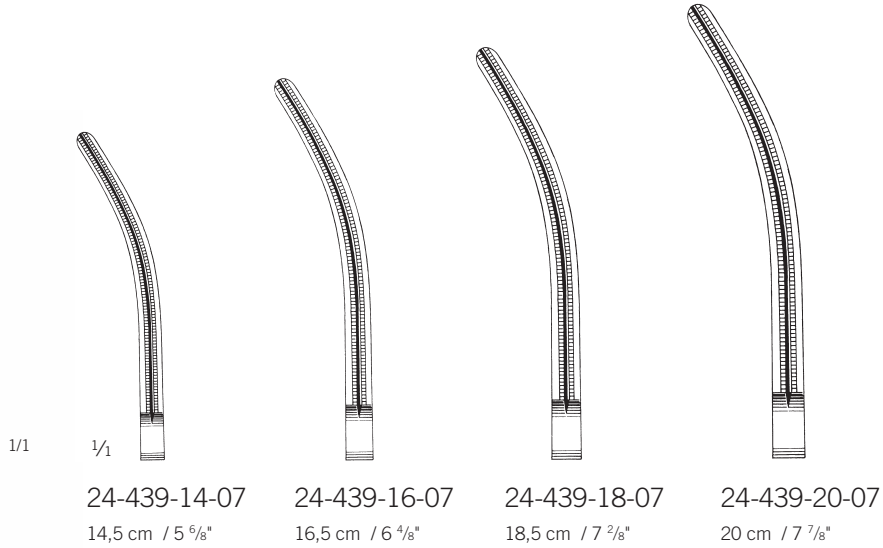

24-439-14-07
 14,5 cm / 5 6/8"

24-439-16-07
 16,5 cm / 6 4/8"

24-439-18-07
 18,5 cm / 7 2/8"

24-439-20-07
 20 cm / 7 7/8"

Arterienklemmen

Haemostatic Forceps
Pinzas hemostáticas
Pincers hémostatiques
Pinze emostatiche



1/2

Spencer-Wells
13-248-13-07 -
13-249-20-07



13-248-13-07
13 cm / 5 1/8"

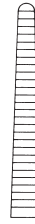

13-248-14-07
14,5 cm / 5 6/8"



13-248-15-07
15,5 cm / 6 1/8"



13-248-18-07
18,5 cm / 7 2/8"



13-248-20-07
20 cm / 7 7/8"



13-249-13-07
13 cm / 5 1/8"



13-249-14-07
14 cm / 5 4/8"



13-249-15-07
15 cm / 5 7/8"



13-249-18-07
18 cm / 7 1/8"



13-249-20-07
20 cm / 7 7/8"

Arterien-, Präparier- und Peripherieklemmen

Haemostatic-, Dissecting and Peripheral Forceps
 Pinzas hemostáticas, de disección y periféricas
 Pincès hémostatiques, à dissection et périphériques
 Pinze emostatiche, da dissezione e periferiche

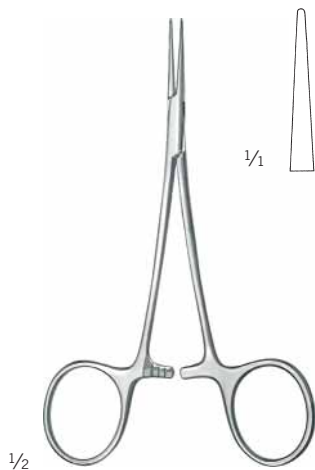

13-302-12-07

12,5 cm / 4 7/8"

Fadenklemme, glattes Maul
 Ligature Forceps, smooth jaw
 Pinza para hilos, boca lisa
 Pince à ligatures, mors lisse
 Pinza per legature, morso liscio



Mixer-Baby
 13-303-02-07

13 cm / 5 1/8"



13-306-10-07

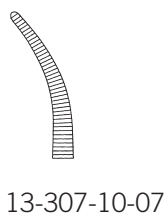

13-307-10-07



kreuzgerieftes Maul
 cross serrated jaw
 boca estriada en forma de cruz
 mors à rainures croisées
 morso con striatura cruciforme

Hartmann
 13-306-10-07 -
 13-307-10-07

10 cm / 3 7/8"

13-309-12-07

12 cm / 4 5/8"

Fadenklemme
 Ligature Forceps
 Pinza para hilos
 Pince à ligatures
 Pinza per legature

Arterienklemmen

Haemostatic Forceps
 Pinzas hemostáticas
 Pinces hémostatiques
 Pinze emostatiche



1/2

Halsted-Mosquito
 13-310-12-07 -
 13-313-14-07

1/4				
	13-310-12-07 12,5 cm / 4 7/8"	13-310-14-07 14,5 cm / 5 6/8"	13-311-12-07 12 cm / 4 6/8"	13-311-14-07 14 cm / 5 4/8"
1/4				
	13-312-12-07 12,5 cm / 4 7/8"	13-312-14-07 14,5 cm / 5 6/8"	13-313-12-07 12,5 cm / 4 7/8"	13-313-14-07 14,5 cm / 5 6/8"
	1:2	1:2	1:2	1:2



1/2

Halsted-Mosquito
 13-310-62-09 -
 13-313-62-09

Ti	1/4				
		13-310-62-09 12,5 cm / 4 7/8"	13-311-62-09 12 cm / 4 6/8"	13-312-62-09 12 cm / 4 6/8"	13-313-62-09 12 cm / 4 6/8"
			1:2	1:2	

Arterien-, Präparier- und Peripherieklemmen

Haemostatic-, Dissecting and Peripheral Forceps
 Pinzas hemostáticas, de disección y periféricas
 Pincès hémostatiques, à dissection et périphériques
 Pinze emostatiche, da dissezione e periferiche



$\frac{1}{4}$				
	13-316-18-07 18,5 cm / 7 ² / ₈ "	13-316-21-07 21 cm / 8 ² / ₈ "	13-317-18-07 18 cm / 7 ¹ / ₈ "	13-317-21-07 20,5 cm / 8 ¹ / ₈ "



$\frac{1}{2}$

$\frac{1}{4}$				
	13-318-18-07 18,5 cm / 7 ² / ₈ " 1:2	13-318-21-07 21 cm / 8 ² / ₈ " 1:2	13-319-18-07 18 cm / 7 ¹ / ₈ " 1:2	13-319-21-07 20,5 cm / 8 ¹ / ₈ " 1:2

Halsted-Mosquito
 13-316-18-07 -
 13-319-21-07

Arterienklemmen

Haemostatic Forceps
 Pinzas hemostáticas
 Pinces hémostatiques
 Pinze emostatiche



1/2

Mikro-Mosquito
 13-320-10-07 -
 13-323-12-07

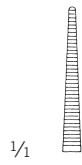

1/1

13-320-10-07
 10 cm / 3 7/8"



13-320-12-07
 12 cm / 4 5/8"



13-321-10-07
 10 cm / 3 7/8"



13-321-12-07
 12 cm / 4 5/8"

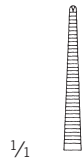

1/1

13-322-10-07
 10 cm / 3 7/8"



13-322-12-07
 12 cm / 4 5/8"



13-323-10-07
 10 cm / 3 7/8"



13-323-12-07
 12 cm / 4 5/8"



1:2



1:2



1:2



1:2



1/2

Leriche
 13-326-15-07 -
 13-329-15-07

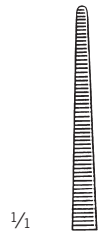

1/1

13-326-15-07
 15,5 cm / 6 1/8"

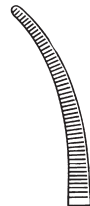

13-327-15-07
 15 cm / 5 7/8"



13-328-15-07
 15,5 cm / 6 1/8"



13-329-15-07
 15 cm / 5 7/8"



1:2



1:2

Arterien-, Präparier- und Peripherieklemmen

Haemostatic-, Dissecting and Peripheral Forceps
 Pinzas hemostáticas, de disección y periféricas
 Pincas hémostatiques, à dissection et périphériques
 Pinze emostatiche, da dissezione e periferiche



1/2

Kelly
 13-330-14-07 -
 13-331-64-09

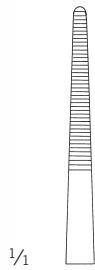

1/4

13-330-14-07
 14,5 cm / 5 9/16"



13-330-64-09
 14,5 cm / 5 9/16"

Ti



13-331-14-07
 14 cm / 5 4/8"



13-331-64-09
 14 cm / 5 4/8"

Ti



1/2

Dunhill
 13-332-12-07
 12,5 cm / 4 7/8"

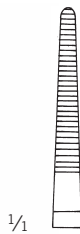

1/4

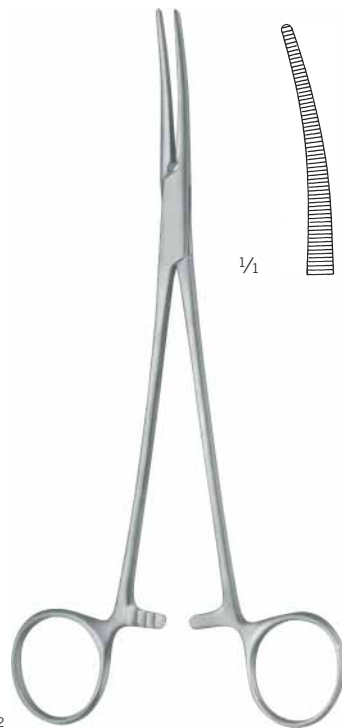

1/2

Dunhill
 13-333-19-07
 18,5 cm / 7 3/8"

1/4



Arterienklemmen, Präparierklemmen

Haemostatic Forceps, Dissecting and Ligature Forceps

Pinzas hemostáticas, Pinzas para preparación y ligadura

Pinces hémostatiques, Pinces à dissecquer et à ligatures

Pinze emostatiche, Pinze per preparazioni e legature



1/1

13-334-16-07

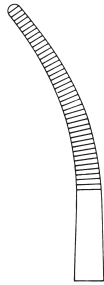

13-335-16-07



1/2

Overholt-Baby
13-339-14-07

13,5 cm / 5 3/8"



1/1

1/2

Kelly-Rankin
13-334-16-07 -
13-335-16-07
16 cm / 6 2/8"



1/1

13-340-14-07



13-340-64-09



13-341-14-07



13-341-64-09

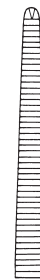

13-342-14-07



13-343-14-07



1/2

Crile
13-340-14-07 -
13-343-14-07
14,5 cm / 5 6/8"

Arterien-, Präparier- und Peripherieklemmen

Haemostatic-, Dissecting and Peripheral Forceps
Pinzas hemostáticas, de disección y periféricas
Pincas hémostatiques, à dissection et périphériques
Pinze emostatiche, da dissezione e periferiche



Crile-Rankin
13-346-16-07 -
13-347-16-07
16 cm / 6 2/8"

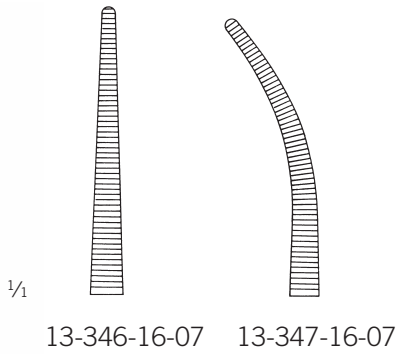

Adson
13-364-18-07 -
13-365-18-07

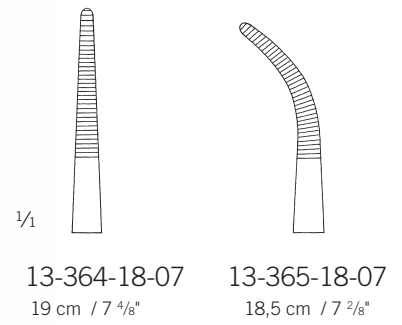

Martin-Fuchsig
13-369-20-07
20,5 cm / 8 1/8"

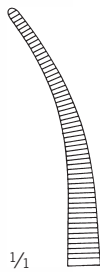

Arterienklemmen

Haemostatic Forceps
 Pinzas hemostáticas
 Pincas hémostatiques
 Pinze emostatiche



1/2

Pean
 13-374-13-07 -
 13-375-16-07

1/1

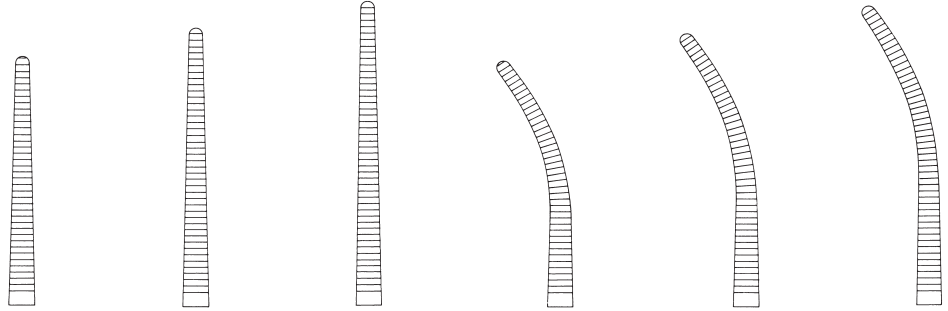

13-374-13-07	13-374-14-07	13-374-16-07	13-375-13-07	13-375-14-07	13-375-16-07
13,5 cm / 5 3/8"	14,5 cm / 5 6/8"	17 cm / 6 6/8"	13 cm / 5 1/8"	14 cm / 5 4/8"	16,5 cm / 6 4/8"



1/2

Pean-Nippon
 13-380-14-07 -
 13-381-18-07

1/1

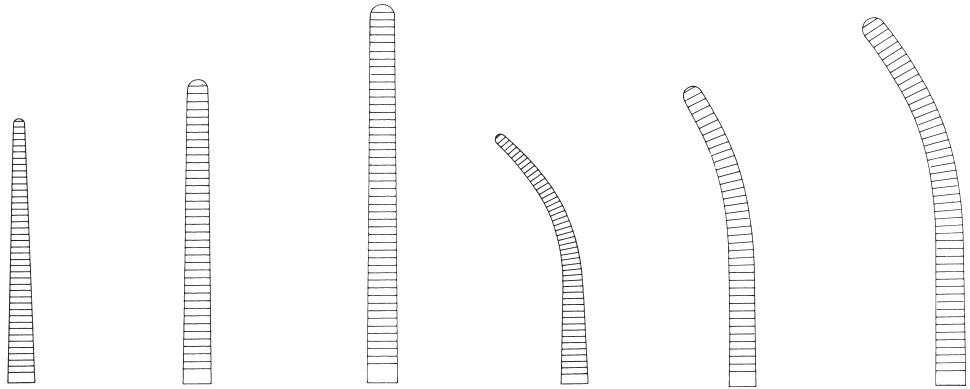

13-380-14-07	13-380-16-07	13-380-18-07	13-381-14-07	13-381-16-07	13-381-18-07
14,5 cm / 5 6/8"	16,5 cm / 6 4/8"	18,5 cm / 7 2/8"	14 cm / 5 4/8"	16 cm / 6 2/8"	18 cm / 7 1/8"

Arterien-, Präparier- und Peripherieklemmen

Haemostatic-, Dissecting and Peripheral Forceps
 Pinzas hemostáticas, de disección y periféricas
 Pincès hémostatiques, à dissection et périphériques
 Pinze emostatiche, da dissezione e periferiche

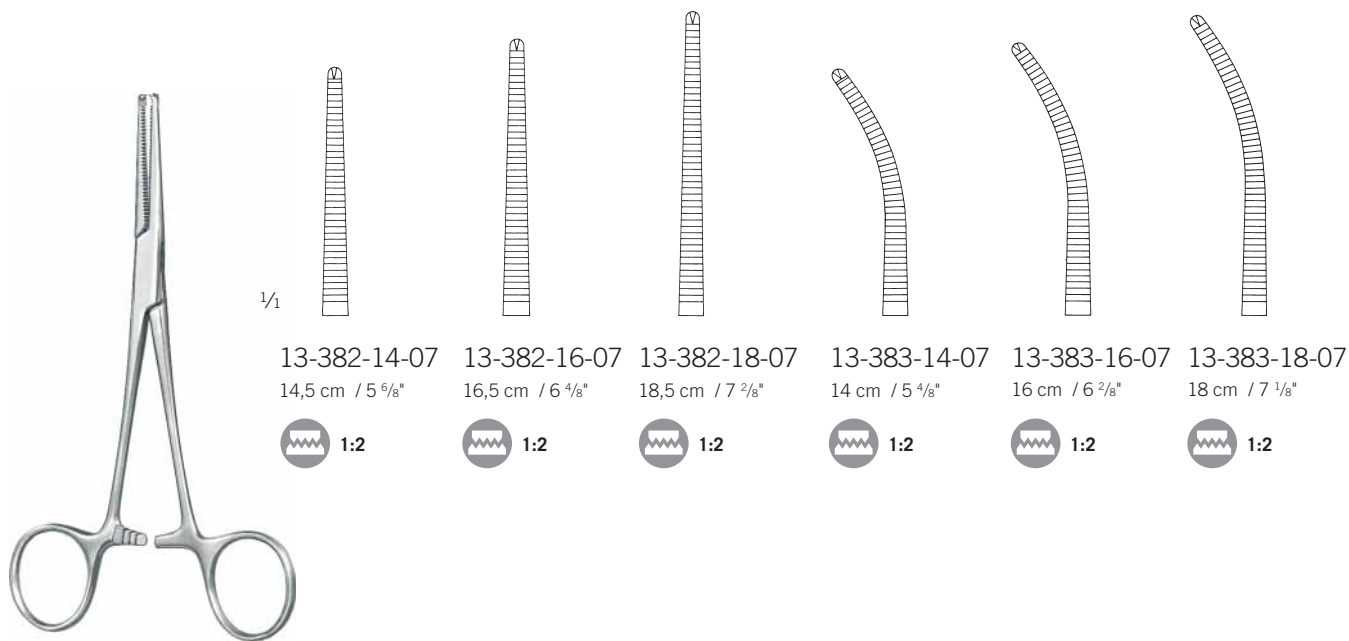

Kocher-Nippon
 13-382-14-07 -
 13-383-18-07

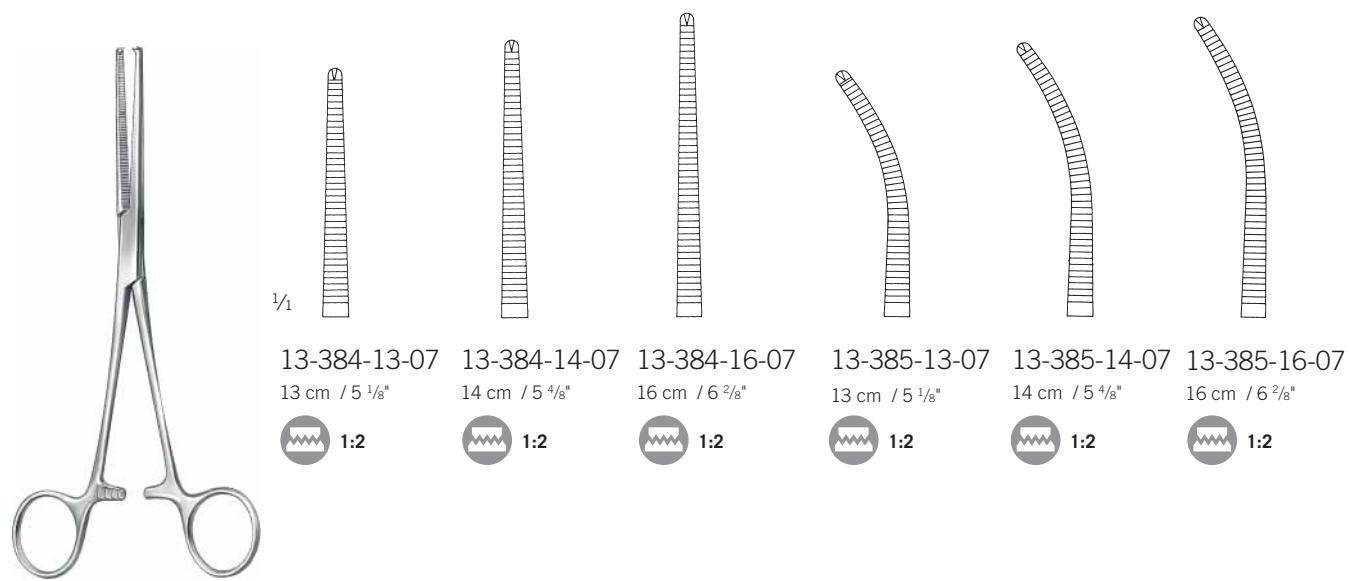

Kocher
 13-384-13-07 -
 13-385-16-07

Arterienklemmen

Haemostatic Forceps
 Pinzas hemostáticas
 Pinces hémostatiques
 Pinze emostatiche

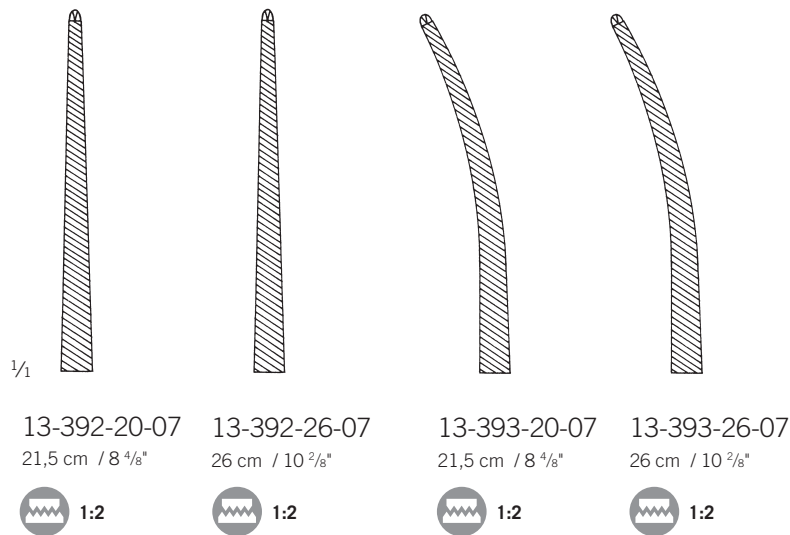
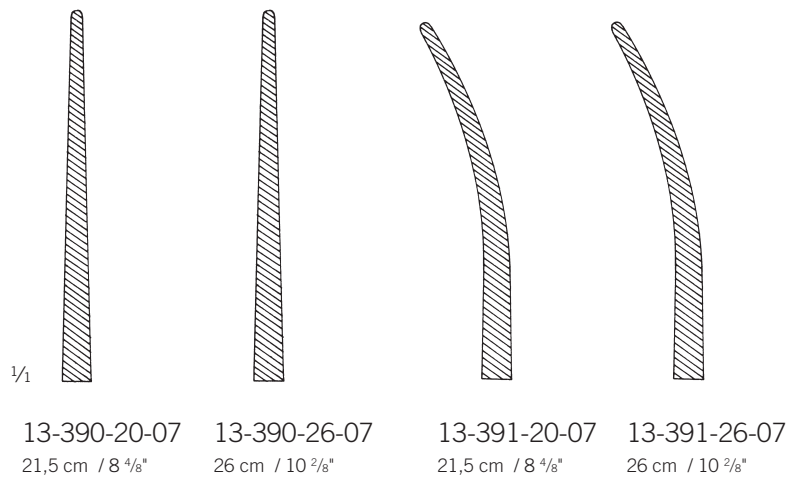

Bengolea
 13-390-20-07 -
 13-393-26-07

Arterien-, Präparier- und Peripherieklemmen

Haemostatic-, Dissecting and Peripheral Forceps
 Pinzas hemostáticas, de disección y periféricas
 Pincès hémostatiques, à dissection et périphériques
 Pinze emostatiche, da dissezione e periferiche



1/1



13-410-14-07
 14,5 cm / 5 7/8"



13-410-16-07
 16,5 cm / 6 4/8"

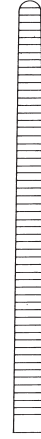

13-410-18-07
 18,5 cm / 7 2/8"



13-410-20-07
 20,5 cm / 8 1/8"

1/1



13-410-22-07
 22,5 cm / 8 7/8"

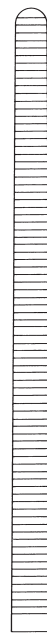

13-410-24-07
 24 cm / 9 4/8"

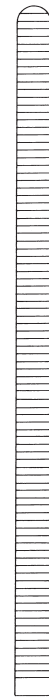

13-410-26-07
 26 cm / 10 2/8"



13-410-30-07
 31 cm / 12 2/8"

1/2



Pean (Rochester)
 13-410-14-07 -
 13-410-30-07

Arterienklemmen

Haemostatic Forceps
Pinzas hemostáticas
Pincès hémostatiques
Pinze emostatiche

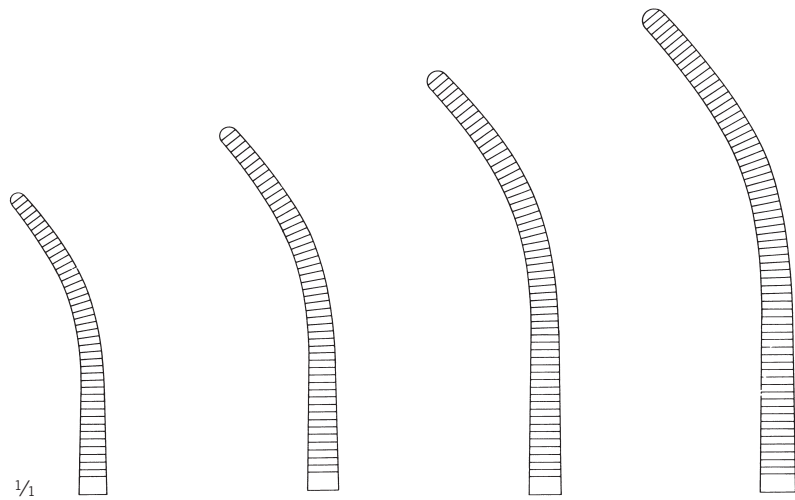

1/1

13-411-14-07
14 cm / 5 4/8"

13-411-16-07
16,5 cm / 6 4/8"

13-411-18-07
18,5 cm / 7 2/8"

13-411-20-07
20,5 cm / 8 1/8"



1/2

1/1

13-411-22-07
22 cm / 8 5/8"

13-411-24-07
24 cm / 9 4/8"

13-411-26-07
26 cm / 10 2/8"

13-411-30-07
30,5 cm / 12"

Pean (Rochester)
13-411-14-07 -
13-411-30-07

Arterien-, Präparier- und Peripherieklemmen

Haemostatic-, Dissecting and Peripheral Forceps
 Pinzas hemostáticas, de disección y periféricas
 Pincas hémostatiques, à dissection et périphériques
 Pinze emostatiche, da dissezione e periferiche



1/1



13-414-14-07
 14,5 cm / 5 7/8"



13-414-16-07
 16,5 cm / 6 4/8"

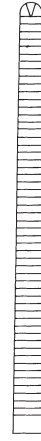

13-414-18-07
 18,5 cm / 7 3/8"



13-414-20-07
 20,5 cm / 8 1/8"



1/2

Kocher (Ochsner)
 13-414-14-07 -
 13-414-30-07

1/1



13-414-22-07
 22,5 cm / 8 7/8"

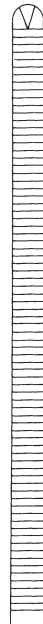

13-414-24-07
 24 cm / 9 4/8"

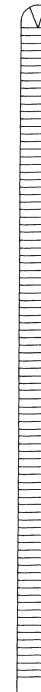

13-414-26-07
 26 cm / 10 2/8"



13-414-30-07
 31 cm / 12 2/8"



Präparierklemmen

Dissecting and Ligature Forceps
 Pinzas para preparación y ligadura
 Pinces à disséquer et à ligatures
 Pinze per preparazioni e legature

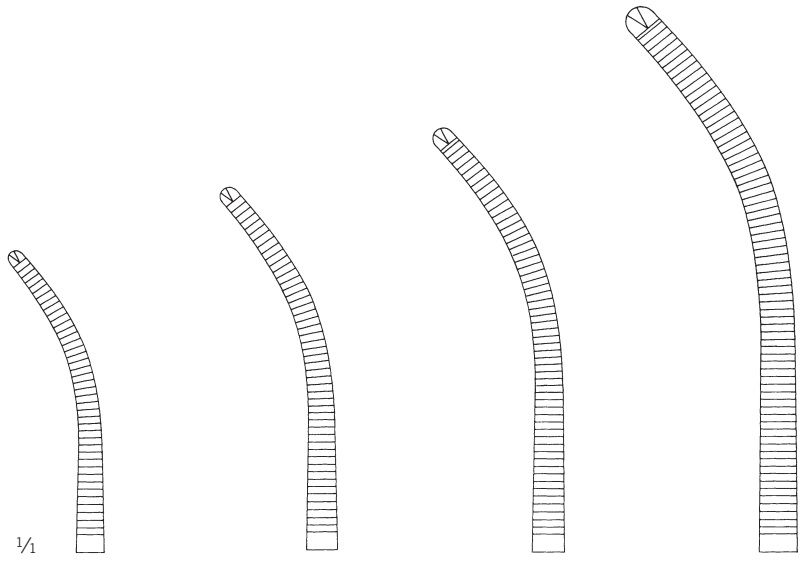

1/4

13-415-14-07
 14 cm / 5 4/8"



13-415-16-07
 16,5 cm / 6 4/8"



13-415-18-07
 18,5 cm / 7 2/8"



13-415-20-07
 20 cm / 7 7/8"



1/2

Kocher (Ochsner)
 13-415-14-07 -
 13-415-30-07

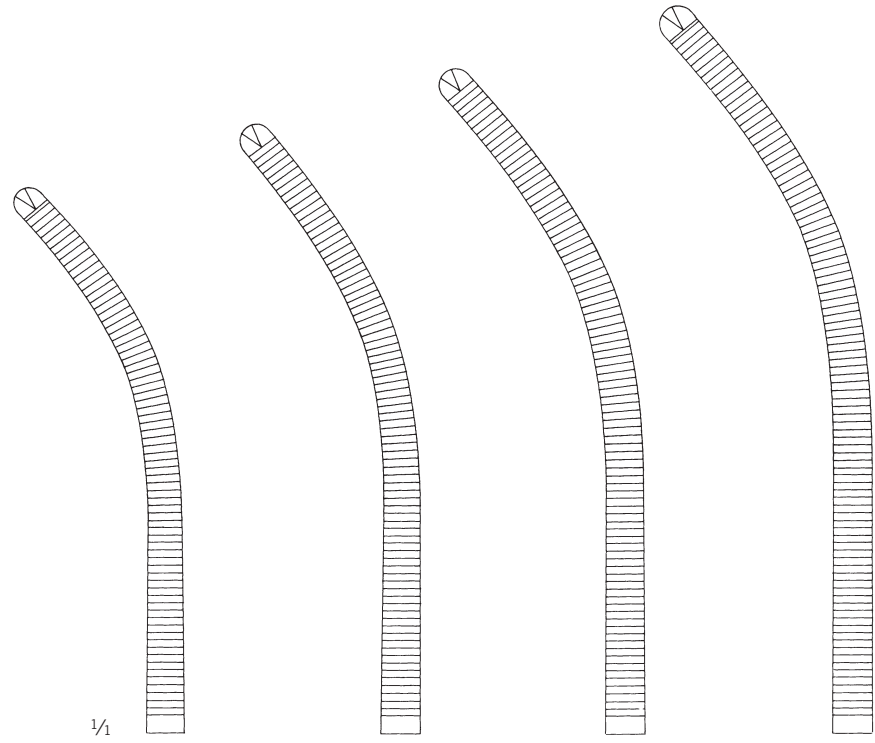

1/2

13-415-22-07
 22,5 cm / 8 7/8"



13-415-24-07
 24 cm / 9 4/8"



13-415-26-07
 26 cm / 10 2/8"



13-415-30-07
 30,5 cm / 12"



Arterien-, Präparier- und Peripherieklemmen

Haemostatic-, Dissecting and Peripheral Forceps
Pinzas hemostáticas, de disección y periféricas
Pincès hémostatiques, à dissection et périphériques
Pinze emostatiche, da dissezione e periferiche

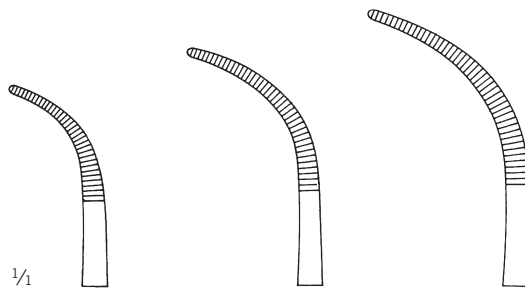

1/1

Fig. 1
13-417-01-07
18,5 cm / 7 2/8"

Fig. 2
13-417-02-07
20,5 cm / 8 1/8"

Fig. 3
13-417-03-07
21cm / 8 2/8"



1/2

Overholt-Martin
13-417-01-07 -
13-417-05-07

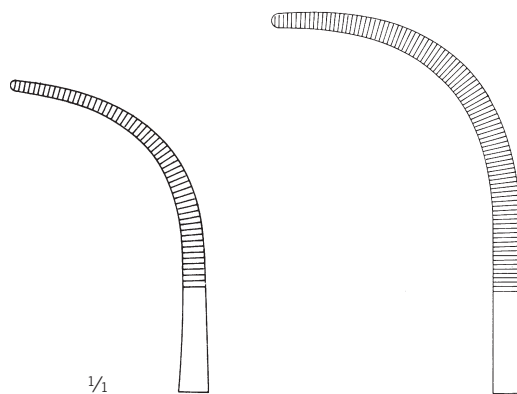

1/1

Fig. 4
13-417-04-07
21,5 cm / 8 2/8"

Fig. 5
13-417-05-07
24,5 cm / 9 5/8"

Präparierklemmen

Dissecting and Ligature Forceps
 Pinzas para preparación y ligadura
 Pincas à disséquer et à ligatures
 Pinze per preparazioni e legature



Mixer-Baby
 13-419-18-07
 18,5 cm / 7 2/8"



Adson-Baby
 13-421-14-07 -
 13-421-18-07

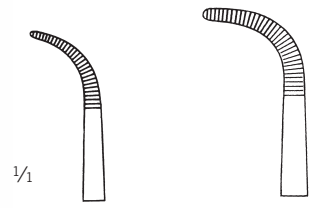

13-421-14-07
 14,5 cm / 5 6/8"

13-421-18-07
 18 cm / 7 1/8"



Heiss
 13-422-20-07 -
 13-425-20-07

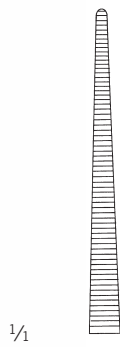

13-422-20-07
 21 cm / 8 2/8"

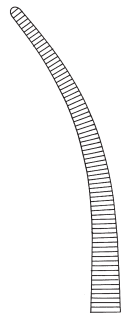

13-423-20-07
 20,5 cm / 8 1/8"

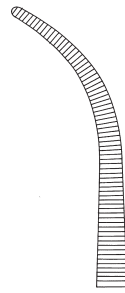

13-425-20-07
 21 cm / 8 2/8"

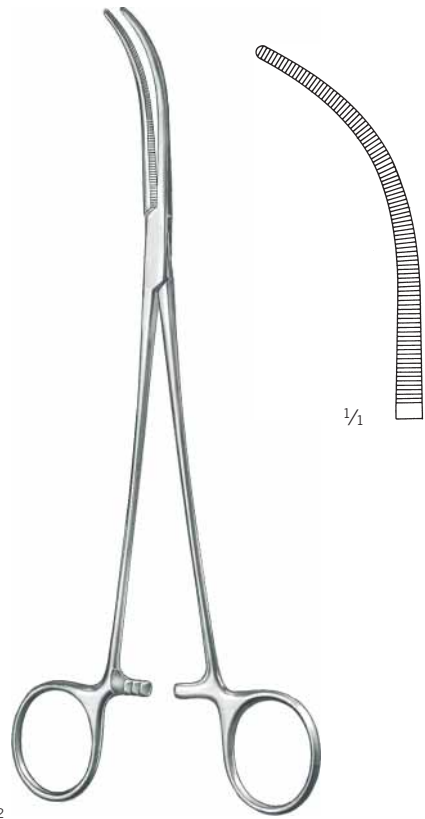

Overholt-Mixer
 13-427-21-07
 22 cm / 8 5/8"

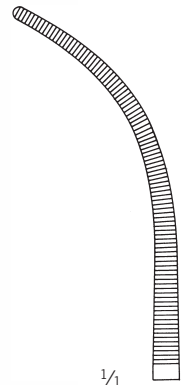

Arterien-, Präparier- und Peripherieklemmen

Haemostatic-, Dissecting and Peripheral Forceps
Pinzas hemostáticas, de disección y periféricas
Pincès hémostatiques, à dissection et périphériques
Pinze emostatiche, da dissezione e periferiche



1/2

Sarot
13-432-24-07 -
13-433-24-07

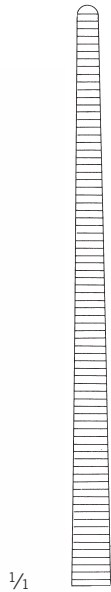

1/1

13-432-24-07
25 cm / 9 7/8"

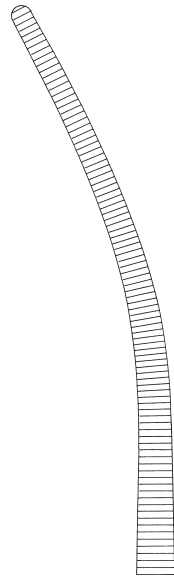

13-433-24-07
24,5 cm / 9 5/8"



1/2

Crafoord
13-439-18-07 -
13-439-24-07

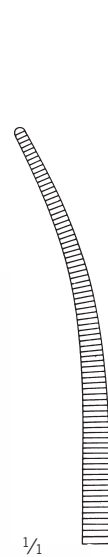

1/1

13-439-18-07
18,5 cm / 7 3/8"

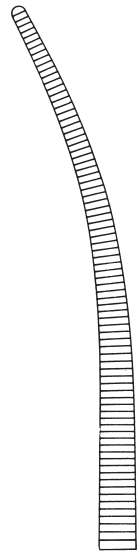

13-439-24-07
24,5 cm / 9 5/8"

Präparierklemmen
Dissecting and Ligature Forceps
Pinzas para preparación y ligadura
Pinces à disséquer et à ligatures
Pinze per preparazioni e legature



1/2

Crafoord-Sellors
13-440-01-07 -
13-440-03-07

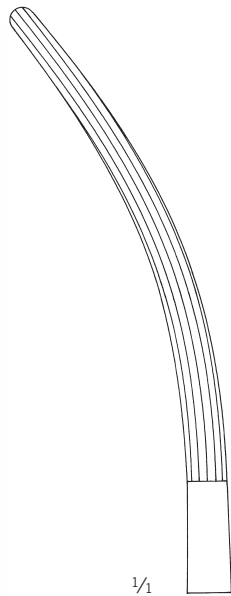

1/1

13-440-01-07
24,5 cm / 9 5/8"

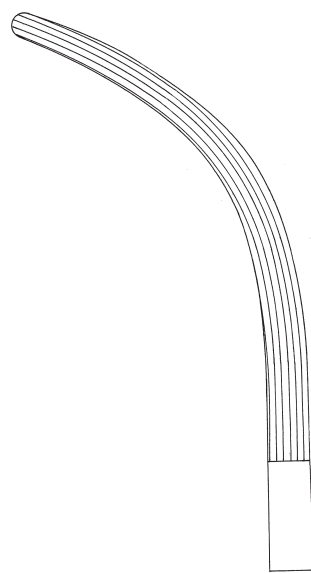

13-440-02-07
23 cm / 9"

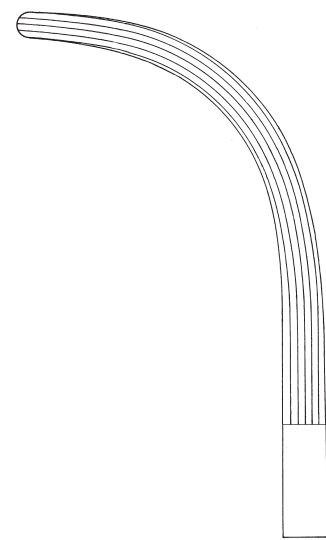

13-440-03-07
22 cm / 8 5/8"

Arterien-, Präparier- und Peripherieklemmen

Haemostatic-, Dissecting and Peripheral Forceps
 Pinzas hemostáticas, de disección y periféricas
 Pincas hémostatiques, à dissection et périphériques
 Pinze emostatiche, da dissezione e periferiche

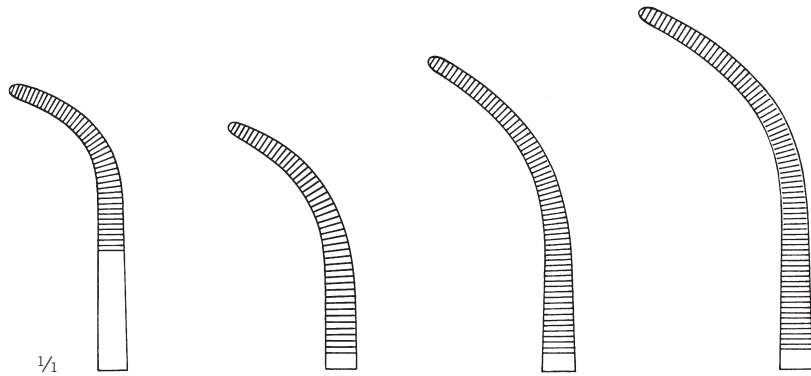

Fig. 1
 13-443-01-07
 20,5 cm / 8 1/8"

Fig. 2
 13-443-02-07
 20 cm / 7 7/8"

Fig. 3
 13-443-03-07
 21,5 cm / 8 4/8"

Fig. 4
 13-443-04-07
 22 cm / 8 5/8"

13-447-01-07
 27 cm / 10 5/8"

13-447-02-07
 26,5 cm / 10 3/8"

13-447-03-07
 27,5 cm / 10 7/8"

13-447-04-07
 28 cm / 11"

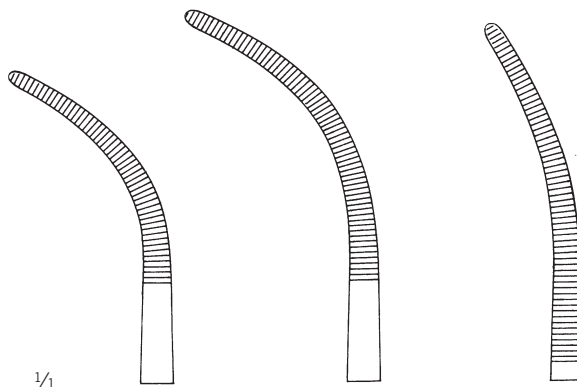

Fig. 5
 13-443-05-07
 21,5 cm / 8 4/8"

Fig. 6
 13-443-06-07
 21,5 cm / 8 2/8"

Fig. 7
 13-443-07-07
 22 cm / 8 5/8"

13-447-05-07
 27,5 cm / 10 7/8"

13-447-06-07
 28 cm / 11"

13-447-07-07
 27,5 cm / 10 7/8"



Overholt-Geissendörfer
 13-443-01-07 -
 13-447-07-07

Präparierklemmen
 Dissecting and Ligature Forceps
 Pinzas para preparación y ligadura
 Pinces à disséquer et à ligatures
 Pinze per preparazioni e legature

finoLine

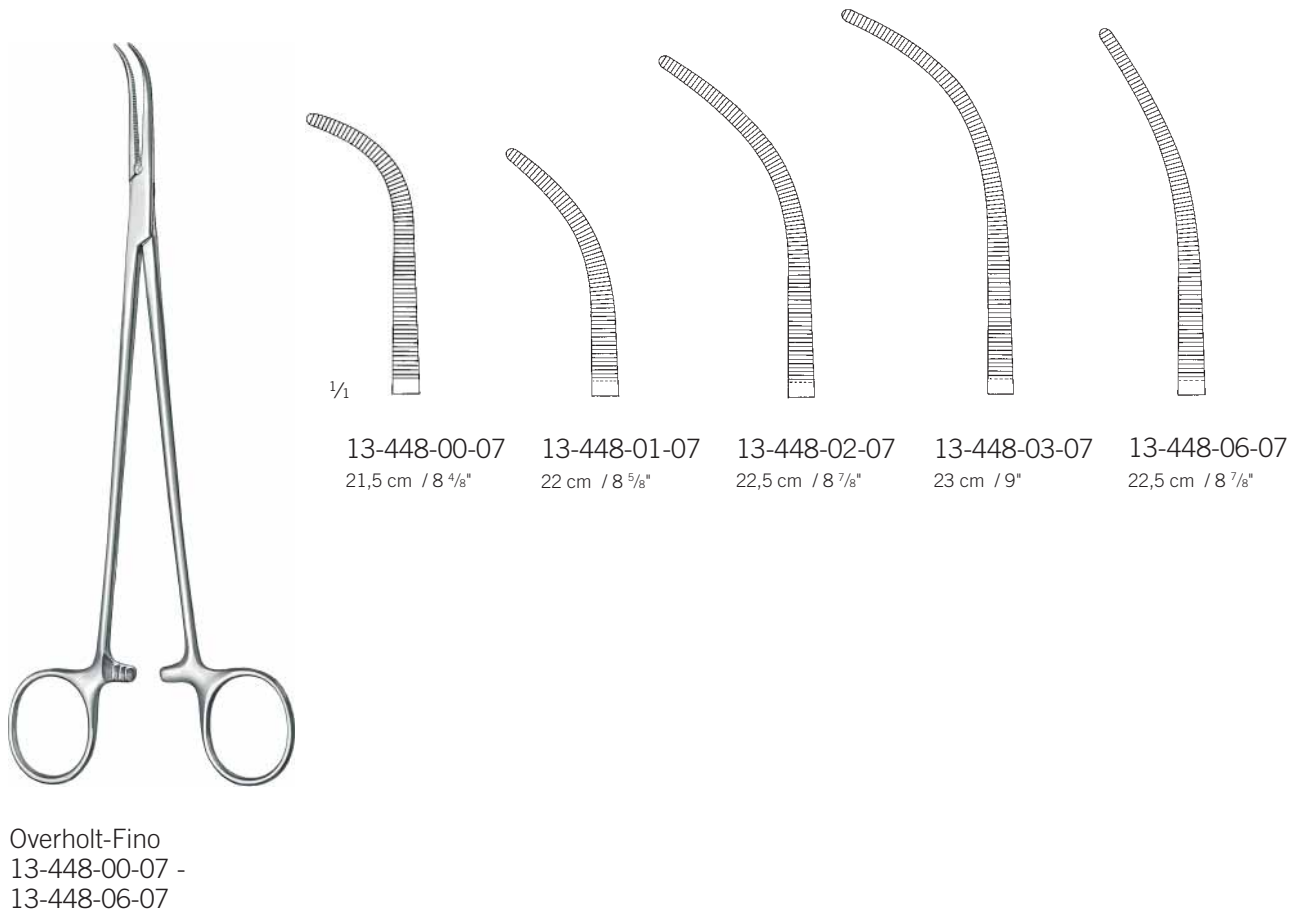

Arterien-, Präparier- und Peripherieklemmen

Haemostatic-, Dissecting and Peripheral Forceps
Pinzas hemostáticas, de disección y periféricas
Pincès hémostatiques, à dissection et périphériques
Pinze emostatiche, da dissezione e periferiche



1/2

Overholt
13-449-00-07 -
13-449-06-07

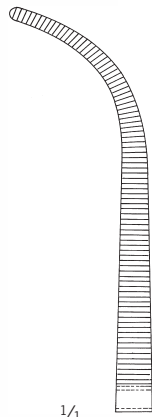

1/1

13-449-00-07
29,5 cm / 11 5/8"

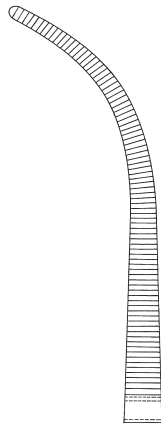

13-449-01-07
29,5 cm / 11 5/8"

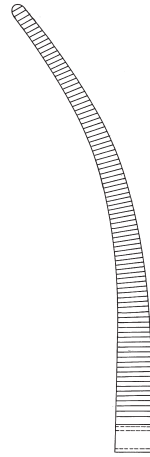

13-449-06-07
30 cm / 11 5/8"

Präparierklemmen
Dissecting and Ligature Forceps
Pinzas para preparación y ligadura
Pincas à disséquer et à ligatures
Pinze per preparazioni e legature

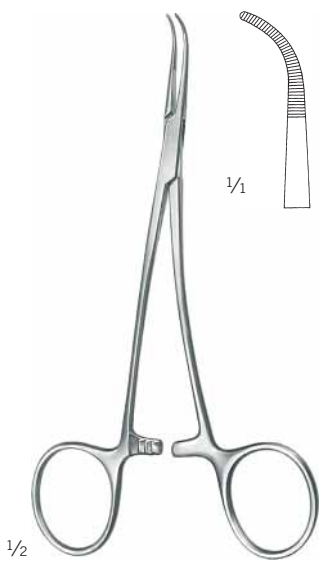

Overholt-Mini
13-450-01-07
15 cm / 5 7/8"



Overholt-Mini
13-450-02-07
20 cm / 7 7/8"

Arterien-, Präparier- und Peripherieklemmen

Haemostatic-, Dissecting and Peripheral Forceps
Pinzas hemostáticas, de disección y periféricas
Pincas hémostatiques, à dissection et périphériques
Pinze emostatiche, da dissezione e periferiche



1/2

Gemini
13-451-13-07 -
13-451-28-07

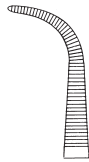

13-451-13-07
13 cm / 5 1/8"

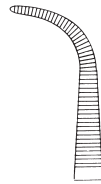

13-451-16-07
16 cm / 6 2/8"



13-451-18-07
18 cm / 7 1/8"

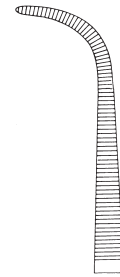

13-451-20-07
21 cm / 8 2/8"

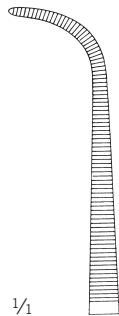

1/1

13-451-23-07
23 cm / 9"

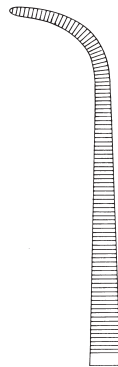

13-451-25-07
25 cm / 9 7/8"

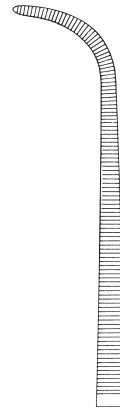

13-451-28-07
28 cm / 11"

Präparierklemmen

Dissecting and Ligature Forceps
 Pinzas para preparación y ligadura
 Pinces à disséquer et à ligatures
 Pinze per preparazioni e legature



1/2

Mini-Gemini
 13-453-18-07 -
 13-453-28-07

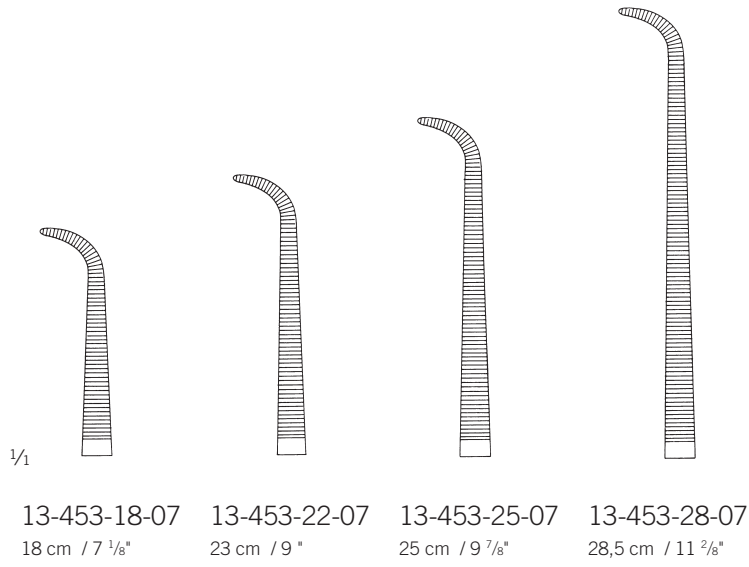

1/2

Rumel
 13-461-01-07 -
 13-461-05-07

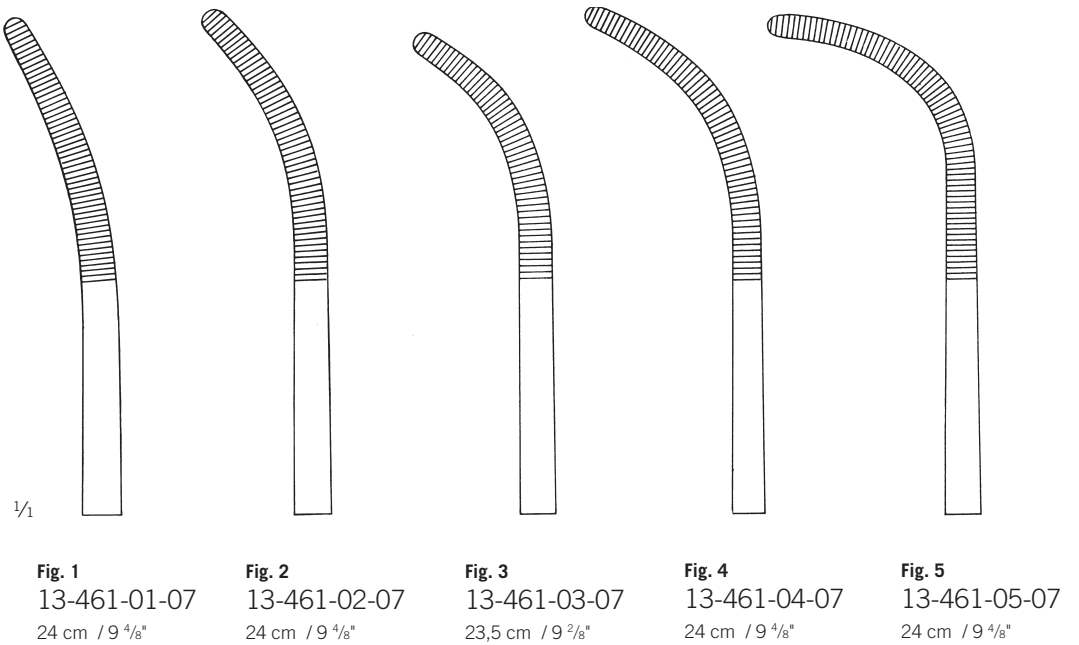

Arterien-, Präparier- und Peripherieklemmen

Haemostatic-, Dissecting and Peripheral Forceps
Pinzas hemostáticas, de disección y periféricas
Pincas hémostatiques, à dissection et périphériques
Pinze emostatiche, da dissezione e periferiche



1/2

Zenker
13-469-01-07 -
13-469-02-07

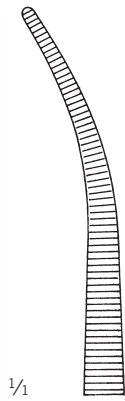

1/1

13-469-01-07
29,5 cm / 11 5/8"

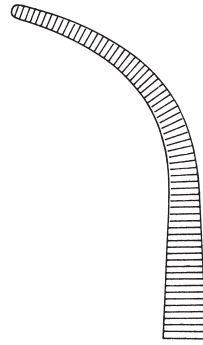

13-469-02-07
28,5 cm / 11 2/8"

Präparierklemmen
 Dissecting and Ligature Forceps
 Pinzas para preparación y ligadura
 Pinces à disséquer et à ligatures
 Pinze per preparazioni e legature

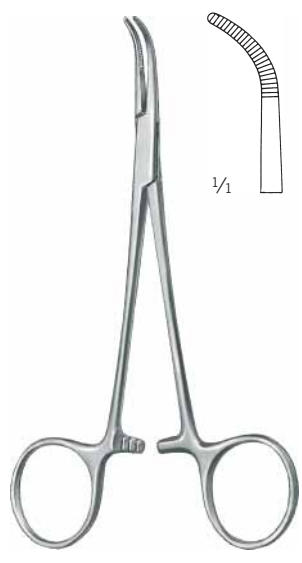

Mixer-Baby
 13-471-14-07
 13 cm / 5 1/8"



Mixer
 13-473-15-07 -
 13-473-19-07

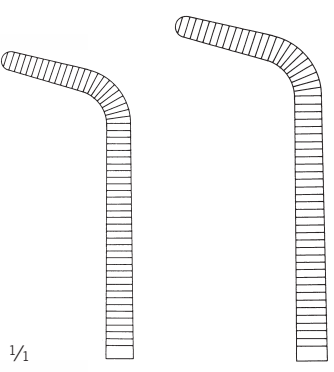

13-473-15-07 16 cm / 6 2/8"
 13-473-19-07 17,5 cm / 6 7/8"

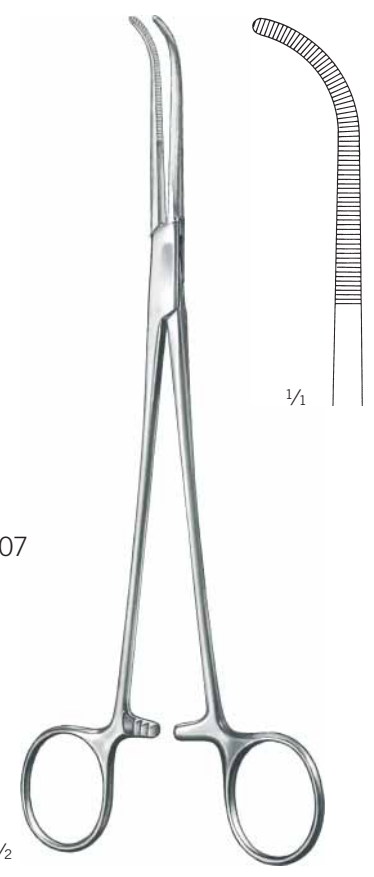

Mixer
 13-483-22-07
 22,5 cm / 8 7/8"

Arterien-, Präparier- und Peripherieklemmen

Haemostatic-, Dissecting and Peripheral Forceps
Pinzas hemostáticas, de disección y periféricas
Pincès hémostatiques, à dissection et périphériques
Pinze emostatiche, da dissezione e periferiche

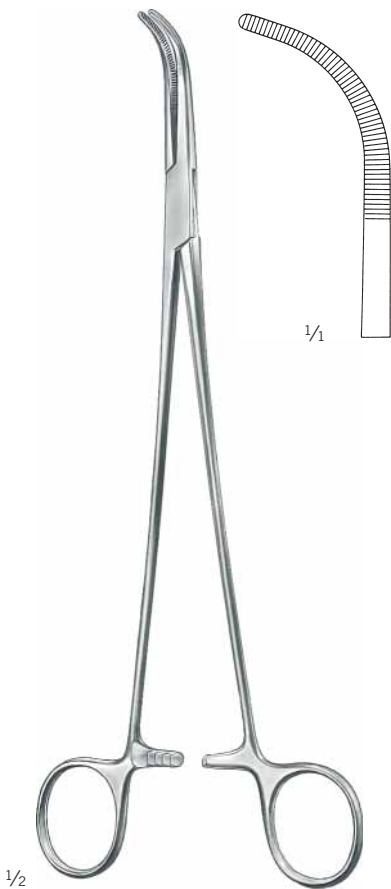

Mixer
13-485-23-07
23 cm / 9"

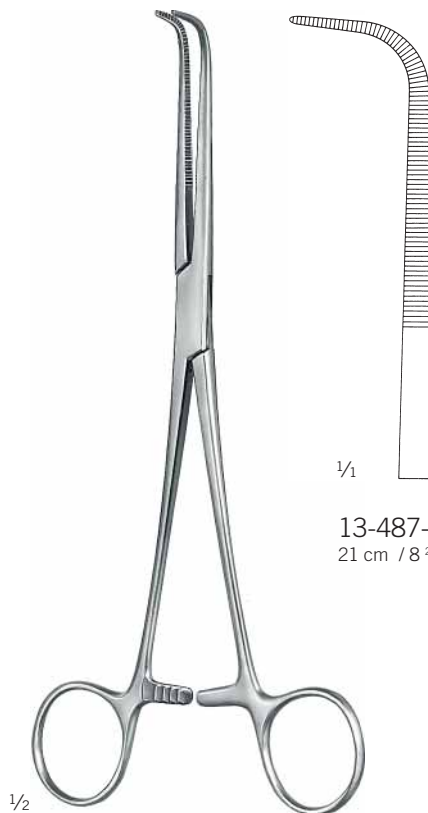

Wikstroem
13-487-21-07 -
13-487-24-07

13-487-21-07
21 cm / 8²/₈"

13-487-24-07
24,5 cm / 9⁵/₈"

Präparierklemmen
 Dissecting and Ligature Forceps
 Pinzas para preparación y ligadura
 Pinces à disséquer et à ligatures
 Pinze per preparazioni e legature



1/2

Mixer
 13-491-22-07 -
 13-495-28-07

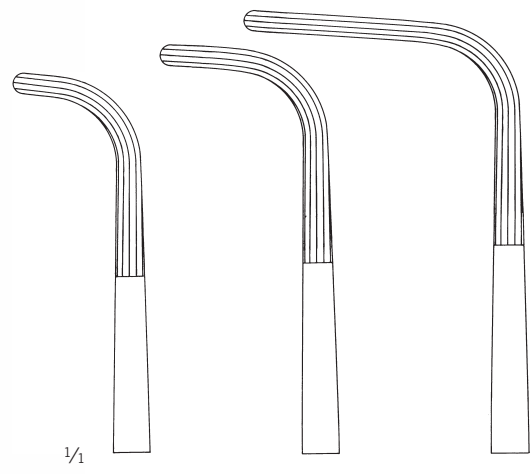

1/1

13-491-22-07 22,5 cm / 8 6/8"
 13-493-25-07 26 cm / 10 2/8"
 13-495-28-07 28 cm / 11"



1/2

McQuigg-Mixer
 13-497-22-07
 23,5 cm / 9 2/8"

1/1







Arterien-, Präparier- und Peripherieklemmen

Haemostatic-, Dissecting and Peripheral Forceps
 Pinzas hemostáticas, de disección y periféricas
 Pincas hémostatiques, à dissection et périphériques
 Pinze emostatiche, da dissezione e periferiche

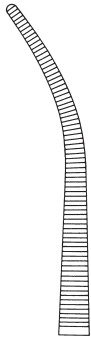
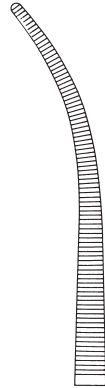

1/2

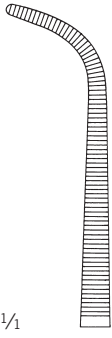
Kelly
 13-577-19-07 -
 13-581-24-07

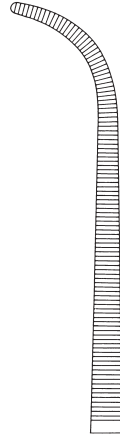
	 1/1 Fig. 1 13-577-19-07 19 cm / 7 4/8"	 1/1 Fig. 1 13-577-22-07 22,5 cm / 8 7/8"	 1/1 Fig. 1 13-577-24-07 23 cm / 9"
	 1/1 Fig. 2 13-579-19-07 19 cm / 7 4/8"	 1/1 Fig. 2 13-579-22-07 22 cm / 8 5/8"	 1/1 Fig. 2 13-579-24-07 23,5 cm / 9 2/8"
	 1/1 Fig. 3 13-581-19-07 18,5 cm / 7 2/8"	 1/1 Fig. 3 13-581-22-07 21,5 cm / 8 4/8"	 1/1 Fig. 3 13-581-24-07 23 cm / 9"

Peritoneumklemmen

Peritoneum Forceps
Pinzas para peritoneo
Pince pour le péritoine
Pinze per peritoneo

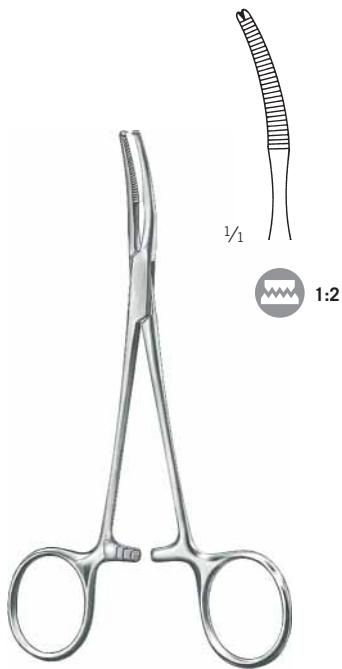

Mikulicz-Baby
13-721-14-07
14,5 cm / 5 7/8"



Mikulicz
13-725-18-07
18,5 cm / 7 3/8"

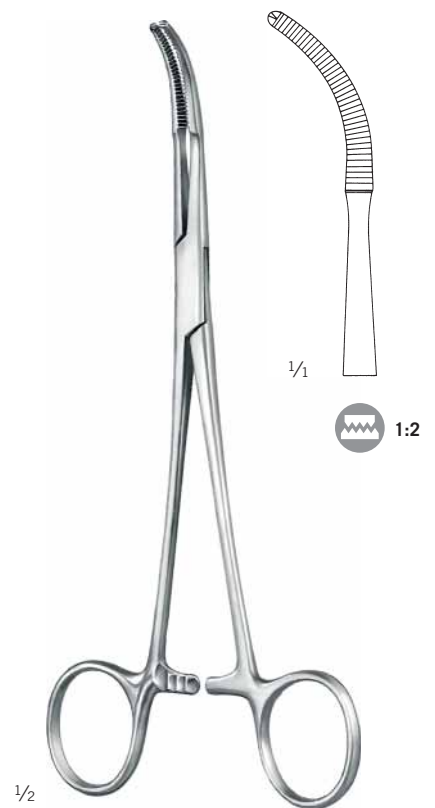

Mikulicz
13-727-20-07
20 cm / 7 7/8"

Arterien-, Präparier- und Peripherieklemmen

Haemostatic-, Dissecting and Peripheral Forceps
Pinzas hemostáticas, de disección y periféricas
Pincés hémostatiques, à dissection et périphériques
Pinze emostatiche, da dissezione e periferiche



Mikulicz
13-745-20-07
20 cm / 7 7/8"

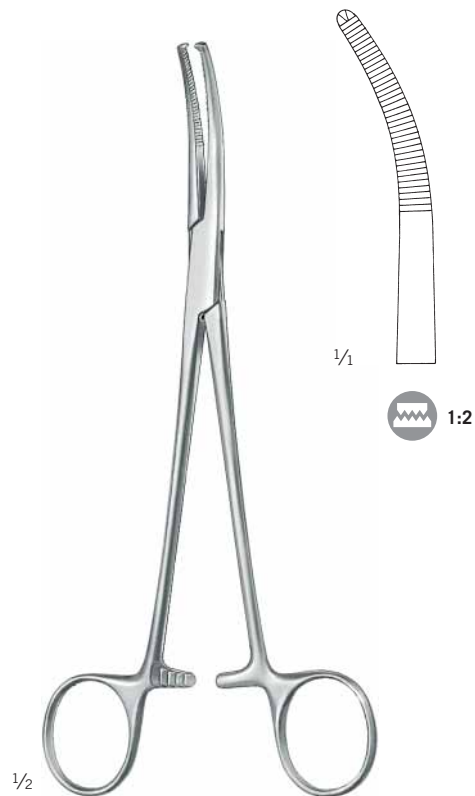

Mikulicz
13-749-21-07
20,5 cm / 8 1/8"

Tuchklemmen

Towel Clamps
Pinzas de campo
Pincas à champs
Pinze fissatele



13-881-05-07

5,5 cm / 2 1/8"

13-881-09-07

8,5 cm / 3 3/8"

1/2

Jones
13-881-05-07 -
13-881-09-07

scharf
sharp
agudo
pointu
acuto



1/2

Jones-Martin
13-883-09-07

8,5 cm / 3 3/8"

scharf, mit Schlauchhalter
sharp, with tube holder
agudo, con porta-tubo
pointu, avec clamp porte-tube
acuto, con porta-tubo



1/2

13-909-11-07

11 cm / 4 3/8"

13-909-13-07

13 cm / 5 1/8"

Backhaus
13-909-11-07 -
13-909-13-07

graziles Modell, scharf
delicate model, sharp
modelo delicado, aguda
modèle gracile, aiguë
modello delicato, acute



1/2

Backhaus
13-913-11-07

11 cm / 4 3/8"

scharf, mit Schlauchhalter
sharp, with tube holder
agudo, con porta-tubo
pointu, avec clamp porte-tube
acuto, con porta-tubo

Arterien-, Präparier- und Peripherieklemmen

Haemostatic-, Dissecting and Peripheral Forceps
 Pinzas hemostáticas, de disección y periféricas
 Pinces hémostatiques, à dissection et périphériques
 Pinze emostatiche, da dissezione e periferiche



13-915-08-07
 9 cm / 3 4/8"

13-915-11-07
 11 cm / 4 3/8"

13-915-13-07
 13 cm / 5 1/8"

13-915-15-07
 16 cm / 6 2/8"

Backhaus
 13-915-08-07 -
 13-915-15-07

scharf
 sharp
 agudo
 pointu
 acuto

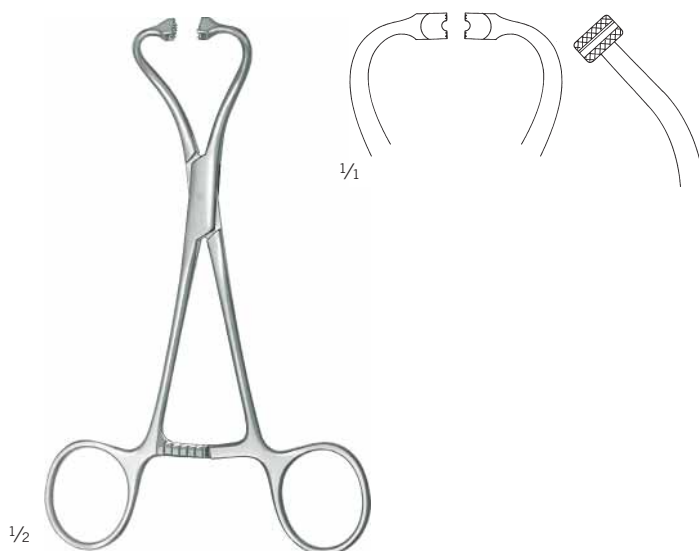

Peers-Bertram modif.
 13-916-15-07

14,5 cm / 5 6/8"

weites Maul zur Schlauchfixierung
 wide jaw for tube fixation
 boca ancha para fijación de tubos
 mors large pour fixation de tube
 morso spalancato per fissare il tubo



Roeder
 13-917-13-07
 13,5 cm / 5 3/8"

Tuchklemmen

Towel Clamps
 Pinzas de campo
 Pincas à champs
 Pinze fissatele

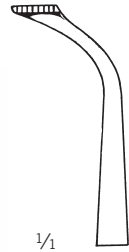

1/1

13-919-10-07

10 cm / 3 7/8"

13-919-13-07

13 cm / 5 1/8"

1/2

Lorna
 13-919-10-07 -
 13-919-13-07

fein gezahnt, breites Maul
 fine serration, wide jaw
 delicadamente dentada, boca ancha
 avec dents fins, mors large
 con denti fini, morso largo



1/2

Bernhard
 13-921-16-07

16,5 cm / 6 4/8"

scharf
 sharp
 agudo
 pointu
 acuto



1/1

13-923-10-07

10,5 cm / 4 1/8"

13-923-13-07

13,5 cm / 5 3/8"

1/2

Tohoku
 13-923-10-07 -
 13-923-13-07

stumpf
 blunt
 romo
 mousse
 smusso

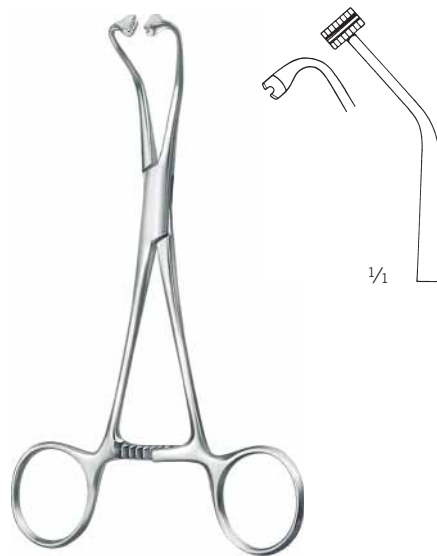

1/2

Peers-Bertram
 13-923-14-07

14,5 cm / 5 6/8"

1/1

Arterien-, Präparier- und Peripherieklemmen

Haemostatic-, Dissecting and Peripheral Forceps
Pinzas hemostáticas, de disección y periféricas
Pincas hémostatiques, à dissection et périphériques
Pinze emostatiche, da dissezione e periferiche



13-924-11-07

11,5 cm / 4 5/8"

13-924-14-07

14 cm / 5 5/8"

1/2

13-924-11-07 -
13-924-14-07

für Papierabdeckung
for paper drapes
para paños de papel
pour couverture en papier
per copertura di carta



1/2

Lane
13-935-20-07
19,5 cm / 7 5/8"

Schlauchklemmen, Rollenklemmen

Tubing Clamps, Tube milking rollers
 Pinzas para tubos, Pinzas de rodillos
 Pincas presse-tubes, Pincas à roulette
 Pinze serratubi, Pinze con rotelle

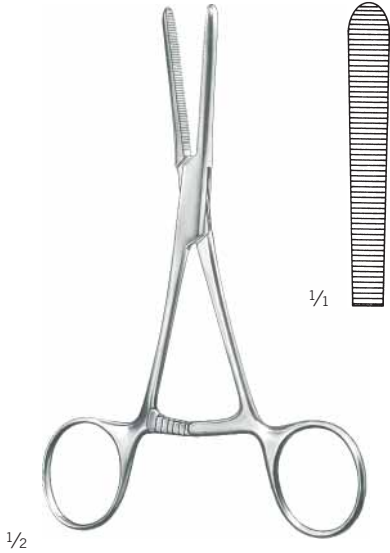

13-940-14-07

14 cm / 5 4/8"

extra lange Sperre
 extra long ratchet
 cremallera extra larga
 crémaillère extrêmement longue
 cremagliera stralunga

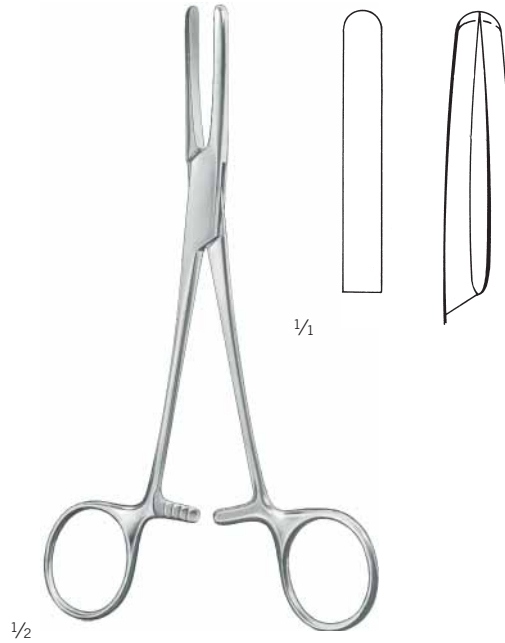

13-942-16-07

16,5 cm / 6 4/8"

glattes Maul
 smooth jaw
 boca lisa
 mors lisse
 morso liscio



13-944-15-07 -
 13-944-20-07

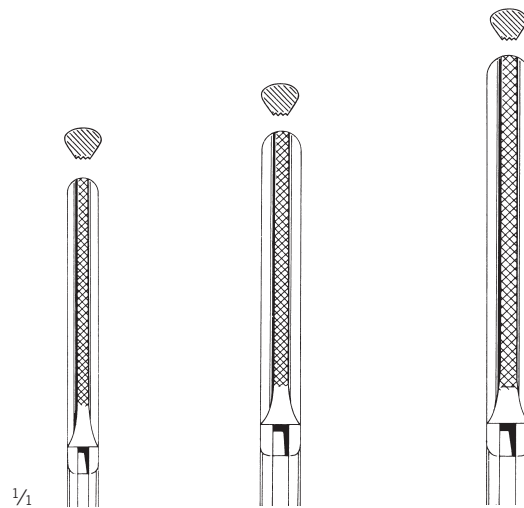

13-944-15-07
 15,5 cm / 6 1/8"

13-944-18-07
 19 cm / 7 4/8"

13-944-20-07
 20,5 cm / 8 1/8"

Arterien-, Präparier- und Peripherieklemmen

Haemostatic-, Dissecting and Peripheral Forceps
 Pinzas hemostáticas, de disección y periféricas
 Pincas hémostatiques, à dissection et périphériques
 Pinze emostatiche, da dissezione e periferiche



1/2



1/1

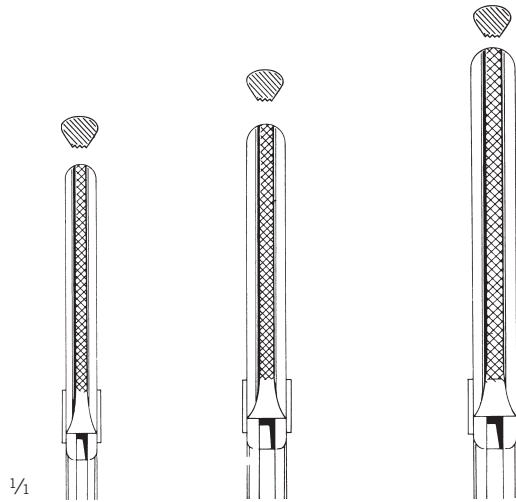

1/1

13-946-15-07
 15,5 cm / 6 1/8"

13-946-18-07
 19 cm / 7 4/8"

13-946-20-07
 20,5 cm / 8 1/8"

13-946-15-07 -
 13-946-20-07

mit Schutzbügel
 with safety guard
 con sbrbo de protección
 avec protection
 con protezione



1/2

Brompton
 13-948-01-04
 16,5 cm / 6 4/8"



1/2

Gunnar-Hey
 13-948-02-07
 18 cm / 7 1/8"

Nummern-Index

Index of order numbers

Índice de números de referencia

Index numérique des références de commande

Elenco dei codici

13

13-248-13-07	4
13-248-14-07	4
13-248-15-07	4
13-248-18-07	4
13-248-20-07	4
13-249-13-07	4
13-249-14-07	4
13-249-15-07	4
13-249-18-07	4
13-249-20-07	4
13-302-12-07	5
13-303-02-07	5
13-306-10-07	5
13-307-10-07	5
13-309-12-07	5
13-310-12-07	6
13-310-14-07	6
13-310-62-09	6
13-311-12-07	6
13-311-14-07	6
13-311-62-09	6
13-312-12-07	6
13-312-14-07	6
13-312-62-09	6
13-313-12-07	6
13-313-14-07	6
13-313-62-09	6
13-316-18-07	7
13-316-21-07	7
13-317-18-07	7
13-317-21-07	7
13-318-18-07	7
13-318-21-07	7
13-319-18-07	7
13-319-21-07	7
13-320-10-07	8
13-320-12-07	8
13-321-10-07	8
13-321-12-07	8
13-322-10-07	8
13-322-12-07	8
13-323-10-07	8
13-323-12-07	8
13-326-15-07	8
13-327-15-07	8
13-328-15-07	8
13-329-15-07	8
13-330-14-07	9
13-330-64-09	9
13-331-14-07	9
13-331-64-09	9
13-332-12-07	9
13-333-19-07	9
13-334-16-07	10
13-335-16-07	10
13-339-14-07	10
13-340-14-07	10
13-340-64-09	10
13-341-14-07	10

13-341-64-09	10
13-342-14-07	10
13-343-14-07	10
13-346-16-07	11
13-347-16-07	11
13-364-18-07	11
13-365-18-07	11
13-369-20-07	11
13-374-13-07	12
13-374-14-07	12
13-374-16-07	12
13-375-13-07	12
13-375-14-07	12
13-375-16-07	12
13-380-14-07	12
13-380-16-07	12
13-380-18-07	12
13-381-14-07	12
13-381-16-07	12
13-381-18-07	12
13-382-14-07	13
13-382-16-07	13
13-382-18-07	13
13-383-14-07	13
13-383-16-07	13
13-383-18-07	13
13-384-13-07	13
13-384-14-07	13
13-384-16-07	13
13-385-13-07	13
13-385-14-07	13
13-385-16-07	13
13-390-20-07	14
13-390-26-07	14
13-391-20-07	14
13-391-26-07	14
13-392-20-07	14
13-392-26-07	14
13-393-20-07	14
13-393-26-07	14
13-410-14-07	15
13-410-16-07	15
13-410-18-07	15
13-410-20-07	15
13-410-22-07	15
13-410-24-07	15
13-410-26-07	15
13-410-30-07	15
13-411-14-07	16
13-411-16-07	16
13-411-18-07	16
13-411-20-07	16
13-411-22-07	16
13-411-24-07	16
13-411-26-07	16
13-411-30-07	16
13-414-14-07	17
13-414-16-07	17
13-414-18-07	17
13-414-20-07	17

13-414-22-07	17
13-414-24-07	17
13-414-26-07	17
13-414-30-07	17
13-415-14-07	18
13-415-16-07	18
13-415-18-07	18
13-415-20-07	18
13-415-22-07	18
13-415-24-07	18
13-415-26-07	18
13-415-30-07	18
13-417-01-07	19
13-417-02-07	19
13-417-03-07	19
13-417-04-07	19
13-417-05-07	19
13-419-18-07	20
13-421-14-07	20
13-421-18-07	20
13-422-20-07	20
13-423-20-07	20
13-425-20-07	20
13-427-21-07	20
13-432-24-07	21
13-433-24-07	21
13-439-18-07	21
13-439-24-07	21
13-440-01-07	22
13-440-02-07	22
13-440-03-07	22
13-443-01-07	23
13-443-02-07	23
13-443-03-07	23
13-443-04-07	23
13-443-05-07	23
13-443-06-07	23
13-443-07-07	23
13-447-01-07	23
13-447-02-07	23
13-447-03-07	23
13-447-04-07	23
13-447-05-07	23
13-447-06-07	23
13-447-07-07	23
13-448-00-07	24
13-448-01-07	24
13-448-02-07	24
13-448-03-07	24
13-448-06-07	24
13-449-00-07	25
13-449-01-07	25
13-449-06-07	25
13-450-01-07	26
13-450-02-07	26
13-451-13-07	27
13-451-16-07	27
13-451-18-07	27
13-451-20-07	27
13-451-23-07	27

13-451-25-07	27
13-451-28-07	27
13-453-18-07	28
13-453-22-07	28
13-453-25-07	28
13-453-28-07	28
13-461-01-07	28
13-461-02-07	28
13-461-03-07	28
13-461-04-07	28
13-461-05-07	28
13-469-01-07	29
13-469-02-07	29
13-471-14-07	30
13-473-15-07	30
13-473-19-07	30
13-483-22-07	30
13-485-23-07	31
13-487-21-07	31
13-487-24-07	31
13-491-22-07	32
13-493-25-07	32
13-495-28-07	32
13-497-22-07	32
13-577-19-07	33
13-577-22-07	33
13-577-24-07	33
13-579-19-07	33
13-579-22-07	33
13-579-24-07	33
13-581-19-07	33
13-581-22-07	33
13-581-24-07	33
13-721-14-07	34
13-725-18-07	34
13-727-20-07	34
13-745-20-07	35
13-749-21-07	35
13-881-05-07	36
13-881-09-07	36
13-883-09-07	36
13-909-11-07	36
13-909-13-07	36
13-913-11-07	36
13-915-08-07	37
13-915-11-07	37
13-915-13-07	37
13-915-15-07	37
13-916-15-07	37
13-917-13-07	37
13-919-10-07	38
13-919-13-07	38
13-921-16-07	38
13-923-10-07	38
13-923-13-07	38
13-923-14-07	38
13-924-11-07	39
13-924-14-07	39
13-935-20-07	39
13-940-14-07	40

13-942-16-07	40
13-944-15-07	40
13-944-18-07	40
13-944-20-07	40
13-946-15-07	41
13-946-18-07	41
13-946-20-07	41
13-948-01-04	41
13-948-02-07	41

24

24-300-16-07	2
24-301-16-07	2
24-302-15-07	2
24-303-15-07	2
24-438-12-07	2
24-438-14-07	3
24-438-16-07	3
24-438-18-07	3
24-438-20-07	3
24-439-12-07	2
24-439-14-07	3
24-439-16-07	3
24-439-18-07	3
24-439-20-07	3

Arterien-, Präparier- und Peripherieklemmen

Haemostatic-, Dissecting and Peripheral Forceps

Arterien-, Präparier- und Peripherieklemmen

Arterien-, Präparier- und Peripherieklemmen

Arterien-, Präparier- und Peripherieklemmen



KLS Martin Group

Karl Leibinger Medizintechnik GmbH & Co. KG
78570 Mühlheim · Germany
Tel. +49 7463 838-0
info@klsmartin.com

KLS Martin GmbH + Co. KG
79224 Umkirch · Germany
Tel. +49 7665 9802-0
info@klsmartin.com

Stuckenbrock Medizintechnik GmbH
78532 Tuttlingen · Germany
Tel. +49 7461 165880
verwaltung@stuckenbrock.de

Rudolf Buck GmbH
78570 Mühlheim · Germany
Tel. +49 7463 99516-30
info@klsmartin.com

KLS Martin France SARL
68200 Mulhouse · France
Tel. +33 3 8951 3150
france@klsmartin.com

Martin Italia S.r.l.
20864 Agrate Brianza (MB) · Italy
Tel. +39 039 605 6731
italia@klsmartin.com

Martin Nederland/Marned B.V.
1271 AG Huizen · The Netherlands
Tel. +31 35 523 4538
nederland@klsmartin.com

KLS Martin UK Ltd.
Reading RG1 3EU · United Kingdom
Tel. +44 1189 000 570
uk@klsmartin.com

Nippon Martin K.K.
Osaka 541-0046 · Japan
Tel. +81 6 62 28 9075
nippon@klsmartin.com

KLS Martin L.P.
Jacksonville, FL 32246 · USA
Tel. +1 904 641 7746
usa@klsmartin.com

KLS Martin do Brasil Ltda.
CEP 04.531-011 São Paulo · Brazil
Tel.: +55 11 3554 2299
brazil@klsmartin.com

KLS Martin Australia Pty Limited
Artarmon NSW 2064 · Australia
Tel.: +61 2 9439 5316
australia@klsmartin.com

KLS Martin Malaysia
10200 Penang · Malaysia
Tel. +604 263 2566
malaysia@klsmartin.com

Gebrüder Martin GmbH & Co. KG
Representative Office
121471 Moscow · Russia
Tel. +7 499 792-76-19
russia@klsmartin.com

Gebrüder Martin GmbH & Co. KG
Representative Office
201203 Shanghai · China
Tel. +86 21 2898 6611
china@klsmartin.com

Gebrüder Martin GmbH & Co. KG
Representative Office
Dubai · United Arab Emirates
Tel. +971 4 454 1655
middleeast@klsmartin.com

1923 | SURGICAL
2013 | INNOVATION
YEARS

Gebrüder Martin GmbH & Co. KG

A company of the KLS Martin Group

KLS Martin Platz 1 · 78532 Tuttlingen · Germany
Postfach 60 · 78501 Tuttlingen · Germany
Tel. +49 7461 706-0 · Fax +49 7461 706-193
info@klsmartin.com · www.klsmartin.com

